

JEE-2008
Paper II

1. A particle P starts from the point $z_0 = 1 + 2i$, where $i = \sqrt{-1}$. It moves first horizontally away from origin by 5 units and then vertically away from origin by 3 units to reach a point z_1 . From z_1 the particle moves $\sqrt{2}$ units in the direction of the vector $\hat{i} + \hat{j}$ and then it moves through an angle $\frac{\pi}{2}$ in anticlockwise direction on a circle with centre at origin, to reach a point z_2 . The point z_2 is given by
- (A) $6 + 7i$ (B) $-7 + 6i$ (C) $7 + 6i$ (D) $-6 + 7i$

Answer

- (A) (B) (C) (D)

2. Let the function $g : (-\infty, \infty) \rightarrow \left(-\frac{\pi}{2}, \frac{\pi}{2}\right)$ be given by $g(u) = 2 \tan^{-1}(e^u) - \frac{\pi}{2}$. Then, g is
- (A) even and is strictly increasing in $(0, \infty)$
 (B) odd and is strictly decreasing in $(-\infty, \infty)$
 (C) odd and is strictly increasing in $(-\infty, \infty)$
 (D) neither even nor odd, but is strictly increasing in $(-\infty, \infty)$

Answer

- (A) (B) (C) (D)

3. Consider a branch of the hyperbola

$$x^2 - 2y^2 - 2\sqrt{2}x - 4\sqrt{2}y - 6 = 0$$

with vertex at the point A . Let B be one of the end points of its latus rectum. If C is the focus of the hyperbola nearest to the point A , then the area of the triangle ABC is

- (A) $1 - \sqrt{\frac{2}{3}}$ (B) $\sqrt{\frac{3}{2}} - 1$ (C) $1 + \sqrt{\frac{2}{3}}$ (D) $\sqrt{\frac{3}{2}} + 1$

Answer

- (A) (B) (C) (D)

4. The area of the region between the curves $y = \sqrt{\frac{1 + \sin x}{\cos x}}$ and $y = \sqrt{\frac{1 - \sin x}{\cos x}}$ bounded by the lines $x = 0$ and $x = \frac{\pi}{4}$ is

- (A) $\int_0^{\sqrt{2}-1} \frac{t}{(1+t^2)\sqrt{1-t^2}} dt$ (B) $\int_0^{\sqrt{2}-1} \frac{4t}{(1+t^2)\sqrt{1-t^2}} dt$
 (C) $\int_0^{\sqrt{2}+1} \frac{4t}{(1+t^2)\sqrt{1-t^2}} dt$ (D) $\int_0^{\sqrt{2}+1} \frac{t}{(1+t^2)\sqrt{1-t^2}} dt$

Answer

- (A) (B) (C) (D)

5. Consider three points $P = (-\sin(\beta - \alpha), -\cos \beta)$, $Q = (\cos(\beta - \alpha), \sin \beta)$ and $R = (\cos(\beta - \alpha + \theta), \sin(\beta - \theta))$, where $0 < \alpha, \beta, \theta < \frac{\pi}{4}$. Then,

- (A) P lies on the line segment RQ
- (B) Q lies on the line segment PR
- (C) R lies on the line segment QP
- (D) P, Q, R are non-collinear

Answer (A) (B) (C) (D)

6. An experiment has 10 equally likely outcomes. Let A and B be two non-empty events of the experiment. If A consists of 4 outcomes, the number of outcomes that B must have so that A and B are independent, is

- (A) 2, 4 or 8
- (B) 3, 6 or 9
- (C) 4 or 8
- (D) 5 or 10

Answer (A) (B) (C) (D)

7. Let two non-collinear unit vectors \hat{a} and \hat{b} form an acute angle. A point P moves so that at any time t the position vector \vec{OP} (where O is the origin) is given by $\hat{a} \cos t + \hat{b} \sin t$. When P is farthest from origin O , let M be the length of \vec{OP} and \hat{u} be the unit vector along \vec{OP} . Then,

- (A) $\hat{u} = \frac{\hat{a} + \hat{b}}{|\hat{a} + \hat{b}|}$ and $M = (1 + \hat{a} \cdot \hat{b})^{\frac{1}{2}}$
- (B) $\hat{u} = \frac{\hat{a} - \hat{b}}{|\hat{a} - \hat{b}|}$ and $M = (1 + \hat{a} \cdot \hat{b})^{\frac{1}{2}}$
- (C) $\hat{u} = \frac{\hat{a} + \hat{b}}{|\hat{a} + \hat{b}|}$ and $M = (1 + 2\hat{a} \cdot \hat{b})^{\frac{1}{2}}$
- (D) $\hat{u} = \frac{\hat{a} - \hat{b}}{|\hat{a} - \hat{b}|}$ and $M = (1 + 2\hat{a} \cdot \hat{b})^{\frac{1}{2}}$

Answer (A) (B) (C) (D)

8. Let

$$I = \int \frac{e^x}{e^{4x} + e^{2x} + 1} dx, \quad J = \int \frac{e^{-x}}{e^{-4x} + e^{-2x} + 1} dx.$$

Then, for an arbitrary constant C , the value of $J - I$ equals

- (A) $\frac{1}{2} \log \left(\frac{e^{4x} - e^{2x} + 1}{e^{4x} + e^{2x} + 1} \right) + C$
- (B) $\frac{1}{2} \log \left(\frac{e^{2x} + e^x + 1}{e^{2x} - e^x + 1} \right) + C$
- (C) $\frac{1}{2} \log \left(\frac{e^{2x} - e^x + 1}{e^{2x} + e^x + 1} \right) + C$
- (D) $\frac{1}{2} \log \left(\frac{e^{4x} + e^{2x} + 1}{e^{4x} - e^{2x} + 1} \right) + C$

Answer (A) (B) (C) (D)

9. Let $g(x) = \log f(x)$ where $f(x)$ is a twice differentiable positive function on $(0, \infty)$ such that $f(x+1) = x f(x)$. Then, for $N = 1, 2, 3, \dots$,

$$g''\left(N + \frac{1}{2}\right) - g''\left(\frac{1}{2}\right) =$$

- (A) $-4\left\{1 + \frac{1}{9} + \frac{1}{25} + \dots + \frac{1}{(2N-1)^2}\right\}$ (B) $4\left\{1 + \frac{1}{9} + \frac{1}{25} + \dots + \frac{1}{(2N-1)^2}\right\}$
 (C) $-4\left\{1 + \frac{1}{9} + \frac{1}{25} + \dots + \frac{1}{(2N+1)^2}\right\}$ (D) $4\left\{1 + \frac{1}{9} + \frac{1}{25} + \dots + \frac{1}{(2N+1)^2}\right\}$

Answer (A) (B) (C) (D)

10. Suppose four distinct positive numbers a_1, a_2, a_3, a_4 are in G.P. Let $b_1 = a_1, b_2 = b_1 + a_2, b_3 = b_2 + a_3$ and $b_4 = b_3 + a_4$.

STATEMENT-1 : The numbers b_1, b_2, b_3, b_4 are neither in A.P. nor in G.P.

and

STATEMENT-2 : The numbers b_1, b_2, b_3, b_4 are in H.P.

- (A) STATEMENT-1 is True, STATEMENT-2 is True; STATEMENT-2 is a correct explanation for STATEMENT-1
 (B) STATEMENT-1 is True, STATEMENT-2 is True; STATEMENT-2 is NOT a correct explanation for STATEMENT-1
 (C) STATEMENT-1 is True, STATEMENT-2 is False
 (D) STATEMENT-1 is False, STATEMENT-2 is True

Answer (A) (B) (C) (D)

11. Let a, b, c, p, q be real numbers. Suppose α, β are the roots of the equation $x^2 + 2px + q = 0$ and $\alpha, \frac{1}{\beta}$ are the roots of the equation $ax^2 + 2bx + c = 0$, where $\beta^2 \notin \{-1, 0, 1\}$.

STATEMENT-1 : $(p^2 - q)(b^2 - ac) \geq 0$

and

STATEMENT-2 : $b \neq pa$ or $c \neq qa$

- (A) STATEMENT-1 is True, STATEMENT-2 is True; STATEMENT-2 is a correct explanation for STATEMENT-1
 (B) STATEMENT-1 is True, STATEMENT-2 is True; STATEMENT-2 is NOT a correct explanation for STATEMENT-1
 (C) STATEMENT-1 is True, STATEMENT-2 is False
 (D) STATEMENT-1 is False, STATEMENT-2 is True

Answer (A) (B) (C) (D)

12. Consider

$$L_1 : 2x + 3y + p - 3 = 0$$

$$L_2 : 2x + 3y + p + 3 = 0,$$

where p is a real number, and $C : x^2 + y^2 + 6x - 10y + 30 = 0$.

STATEMENT-1 : If line L_1 is a chord of circle C , then line L_2 is not always a diameter of circle C .

and

STATEMENT-2 : If line L_1 is a diameter of circle C , then line L_2 is not a chord of circle C .

- (A) STATEMENT-1 is True, STATEMENT-2 is True; STATEMENT-2 is a correct explanation for STATEMENT-1
 (B) STATEMENT-1 is True, STATEMENT-2 is True; STATEMENT-2 is **NOT** a correct explanation for STATEMENT-1
 (C) STATEMENT-1 is True, STATEMENT-2 is False
 (D) STATEMENT-1 is False, STATEMENT-2 is True

Answer

- (A)
 (B)
 (C)
 (D)

13. Let a solution $y = y(x)$ of the differential equation

$$x\sqrt{x^2 - 1} \, dy - y\sqrt{y^2 - 1} \, dx = 0$$

satisfy $y(2) = \frac{2}{\sqrt{3}}$.

STATEMENT-1 : $y(x) = \sec\left(\sec^{-1} x - \frac{\pi}{6}\right)$

and

STATEMENT-2 : $y(x)$ is given by

$$\frac{1}{y} = \frac{2\sqrt{3}}{x} - \sqrt{1 - \frac{1}{x^2}}$$

- (A) STATEMENT-1 is True, STATEMENT-2 is True; STATEMENT-2 is a correct explanation for STATEMENT-1
 (B) STATEMENT-1 is True, STATEMENT-2 is True; STATEMENT-2 is **NOT** a correct explanation for STATEMENT-1
 (C) STATEMENT-1 is True, STATEMENT-2 is False
 (D) STATEMENT-1 is False, STATEMENT-2 is True

Answer

- (A)
 (B)
 (C)
 (D)

Paragraph for Question Nos. 14 to 16

Consider the function $f : (-\infty, \infty) \rightarrow (-\infty, \infty)$ defined by

$$f(x) = \frac{x^2 - ax + 1}{x^2 + ax + 1}, \quad 0 < a < 2.$$

14. Which of the following is true?

- (A) $(2+a)^2 f''(1) + (2-a)^2 f''(-1) = 0$ (B) $(2-a)^2 f''(1) - (2+a)^2 f''(-1) = 0$
 (C) $f'(1)f'(-1) = (2-a)^2$ (D) $f'(1)f'(-1) = -(2+a)^2$

Answer

- (A) (B) (C) (D)

15. Which of the following is true?

- (A) $f(x)$ is decreasing on $(-1, 1)$ and has a local minimum at $x = 1$
 (B) $f(x)$ is increasing on $(-1, 1)$ and has a local maximum at $x = 1$
 (C) $f(x)$ is increasing on $(-1, 1)$ but has neither a local maximum nor a local minimum at $x = 1$
 (D) $f(x)$ is decreasing on $(-1, 1)$ but has neither a local maximum nor a local minimum at $x = 1$

Answer

- (A) (B) (C) (D)

16. Let

$$g(x) = \int_0^{e^x} \frac{f'(t)}{1+t^2} dt.$$

Which of the following is true?

- (A) $g'(x)$ is positive on $(-\infty, 0)$ and negative on $(0, \infty)$
 (B) $g'(x)$ is negative on $(-\infty, 0)$ and positive on $(0, \infty)$
 (C) $g'(x)$ changes sign on both $(-\infty, 0)$ and $(0, \infty)$
 (D) $g'(x)$ does not change sign on $(-\infty, \infty)$

Answer

- (A) (B) (C) (D)

Paragraph for Question Nos. 17 to 19

Consider the lines

$$L_1 : \frac{x+1}{3} = \frac{y+2}{1} = \frac{z+1}{2}$$

$$L_2 : \frac{x-2}{1} = \frac{y+2}{2} = \frac{z-3}{3}$$

17. The unit vector perpendicular to both L_1 and L_2 is

(A) $\frac{-\hat{i} + 7\hat{j} + 7\hat{k}}{\sqrt{99}}$

(B) $\frac{-\hat{i} - 7\hat{j} + 5\hat{k}}{5\sqrt{3}}$

(C) $\frac{-\hat{i} + 7\hat{j} + 5\hat{k}}{5\sqrt{3}}$

(D) $\frac{7\hat{i} - 7\hat{j} - \hat{k}}{\sqrt{99}}$

Answer

- (A)
 (B)
 (C)
 (D)

18. The shortest distance between L_1 and L_2 is

(A) 0

(B) $\frac{17}{\sqrt{3}}$

(C) $\frac{41}{5\sqrt{3}}$

(D) $\frac{17}{5\sqrt{3}}$

Answer

- (A)
 (B)
 (C)
 (D)

19. The distance of the point $(1, 1, 1)$ from the plane passing through the point $(-1, -2, -1)$ and whose normal is perpendicular to both the lines L_1 and L_2 is

(A) $\frac{2}{\sqrt{75}}$

(B) $\frac{7}{\sqrt{75}}$

(C) $\frac{13}{\sqrt{75}}$

(D) $\frac{23}{\sqrt{75}}$

Answer

- (A)
 (B)
 (C)
 (D)

20. Consider the lines given by

$$L_1 : x + 3y - 5 = 0$$

$$L_2 : 3x - ky - 1 = 0$$

$$L_3 : 5x + 2y - 12 = 0$$

Match the Statements / Expressions in **Column I** with the Statements / Expressions in **Column II** and indicate your answer by darkening the appropriate bubbles in the 4×4 matrix given in the ORS.

Column I

Column II

- (A) L_1, L_2, L_3 are concurrent, if
- (B) One of L_1, L_2, L_3 is parallel to at least one of the other two, if
- (C) L_1, L_2, L_3 form a triangle, if
- (D) L_1, L_2, L_3 do not form a triangle, if

- (p) $k = -9$
- (q) $k = -\frac{6}{5}$
- (r) $k = \frac{5}{6}$
- (s) $k = 5$

	p	q	r	s
A	<input type="radio"/>	<input type="radio"/>	<input type="radio"/>	<input checked="" type="radio"/>
B	<input checked="" type="radio"/>	<input checked="" type="radio"/>	<input type="radio"/>	<input type="radio"/>
C	<input type="radio"/>	<input type="radio"/>	<input checked="" type="radio"/>	<input type="radio"/>
D	<input checked="" type="radio"/>	<input checked="" type="radio"/>	<input type="radio"/>	<input checked="" type="radio"/>

Answer

21. Match the Statements / Expressions in **Column I** with the Statements / Expressions in **Column II** and indicate your answer by darkening the appropriate bubbles in the 4×4 matrix given in the ORS.

Column I

Column II

- (A) The minimum value of $\frac{x^2 + 2x + 4}{x + 2}$ is
- (B) Let A and B be 3×3 matrices of real numbers, where A is symmetric, B is skew-symmetric, and $(A + B)(A - B) = (A - B)(A + B)$. If $(AB)^t = (-1)^k AB$, where $(AB)^t$ is the transpose of the matrix AB , then the possible values of k are
- (C) Let $a = \log_3 \log_3 2$. An integer k satisfying $1 < 2^{(-k + 3^{-a})} < 2$, must be less than
- (D) If $\sin \theta = \cos \varphi$, then the possible values of $\frac{1}{\pi}(\theta \pm \varphi - \frac{\pi}{2})$ are

- (p) 0
- (q) 1
- (r) 2
- (s) 3

	p	q	r	s
A	<input type="radio"/>	<input type="radio"/>	<input checked="" type="radio"/>	<input type="radio"/>
B	<input type="radio"/>	<input checked="" type="radio"/>	<input type="radio"/>	<input checked="" type="radio"/>
C	<input type="radio"/>	<input type="radio"/>	<input checked="" type="radio"/>	<input checked="" type="radio"/>
D	<input checked="" type="radio"/>	<input type="radio"/>	<input checked="" type="radio"/>	<input type="radio"/>

Answer

22. Consider all possible permutations of the letters of the word ENDEANOEL.

Match the Statements / Expressions in **Column I** with the Statements / Expressions in **Column II** and indicate your answer by darkening the appropriate bubbles in the 4×4 matrix given in the ORS.

Column I	Column II
(A) The number of permutations containing the word ENDEA is	(p) $5!$
(B) The number of permutations in which the letter E occurs in the first and the last positions is	(q) $2 \times 5!$
(C) The number of permutations in which none of the letters D, L, N occurs in the last five positions is	(r) $7 \times 5!$
(D) The number of permutations in which the letters A, E, O occur only in odd positions is	(s) $21 \times 5!$

	p	q	r	s
A	<input checked="" type="radio"/>	<input type="radio"/>	<input type="radio"/>	<input type="radio"/>
B	<input type="radio"/>	<input type="radio"/>	<input type="radio"/>	<input checked="" type="radio"/>
C	<input type="radio"/>	<input checked="" type="radio"/>	<input type="radio"/>	<input type="radio"/>
D	<input type="radio"/>	<input checked="" type="radio"/>	<input type="radio"/>	<input type="radio"/>

Answer

23. Consider a system of three charges $\frac{q}{3}$, $\frac{q}{3}$ and $-\frac{2q}{3}$ placed at points A, B and C, respectively, as shown in the figure. Take O to be the centre of the circle of radius R and angle $CAB = 60^\circ$

Figure :

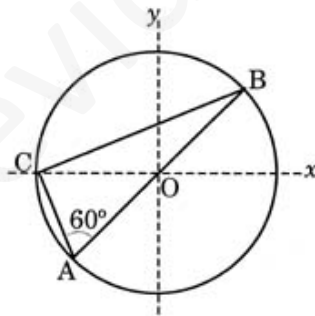

(A) The electric field at point O is $\frac{q}{8\pi\epsilon_0 R^2}$ directed along the negative x -axis

(B) The potential energy of the system is zero

(C) The magnitude of the force between the charges at C and B is $\frac{q^2}{54\pi\epsilon_0 R^2}$

(D) The potential at point O is $\frac{q}{12\pi\epsilon_0 R}$

Answer

- (A)
 (B)
 (C)
 (D)

24. A radioactive sample S1 having an activity of $5\mu\text{Ci}$ has twice the number of nuclei as another sample S2 which has an activity of $10\mu\text{Ci}$. The half lives of S1 and S2 can be
- (A) 20 years and 5 years, respectively
 - (B) 20 years and 10 years, respectively
 - (C) 10 years each
 - (D) 5 years each

Answer

- (A)
 (B)
 (C)
 (D)

25. A transverse sinusoidal wave moves along a string in the positive x -direction at a speed of 10 cm/s . The wavelength of the wave is 0.5 m and its amplitude is 10 cm . At a particular time t , the snap-shot of the wave is shown in figure. The velocity of point P when its displacement is 5 cm is

Figure :

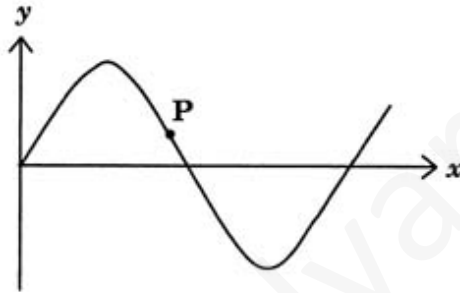

- (A) $\frac{\sqrt{3}\pi}{50} \hat{j}\text{ m/s}$
- (B) $-\frac{\sqrt{3}\pi}{50} \hat{j}\text{ m/s}$
- (C) $\frac{\sqrt{3}\pi}{50} \hat{i}\text{ m/s}$
- (D) $-\frac{\sqrt{3}\pi}{50} \hat{i}\text{ m/s}$

Answer

- (A)
 (B)
 (C)
 (D)

26. A block (B) is attached to two unstretched springs S1 and S2 with spring constants k and $4k$, respectively (see figure I). The other ends are attached to identical supports M1 and M2 not attached to the walls. The springs and supports have negligible mass. There is no friction anywhere. The block B is displaced towards wall 1 by a small distance x (figure II) and released. The block returns and moves a maximum distance y towards wall 2. Displacements x and y are measured with respect to the equilibrium position of the block B. The ratio $\frac{y}{x}$ is

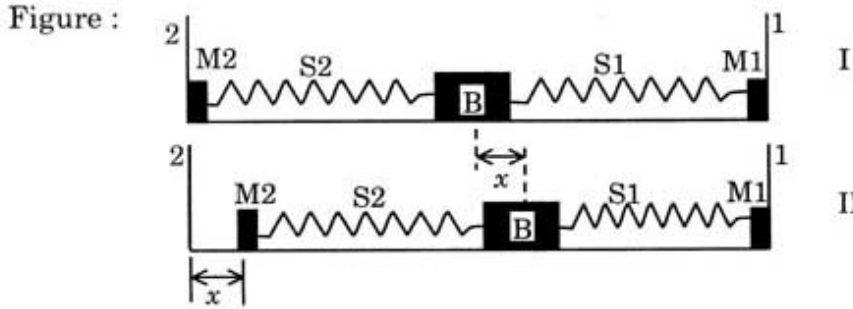

- (A) 4 (B) 2 (C) $\frac{1}{2}$ (D) $\frac{1}{4}$

Answer (A) (B) (C) (D)

27. A bob of mass M is suspended by a massless string of length L . The horizontal velocity V at position A is just sufficient to make it reach the point B. The angle θ at which the speed of the bob is half of that at A, satisfies

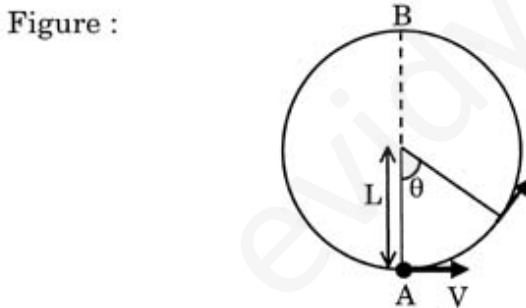

- (A) $\theta = \frac{\pi}{4}$ (B) $\frac{\pi}{4} < \theta < \frac{\pi}{2}$
 (C) $\frac{\pi}{2} < \theta < \frac{3\pi}{4}$ (D) $\frac{3\pi}{4} < \theta < \pi$

Answer (A) (B) (C) (D)

28. A glass tube of uniform internal radius (r) has a valve separating the two identical ends. Initially, the valve is in a tightly closed position. End 1 has a hemispherical soap bubble of radius r . End 2 has sub-hemispherical soap bubble as shown in figure. Just after opening the valve,

Figure :

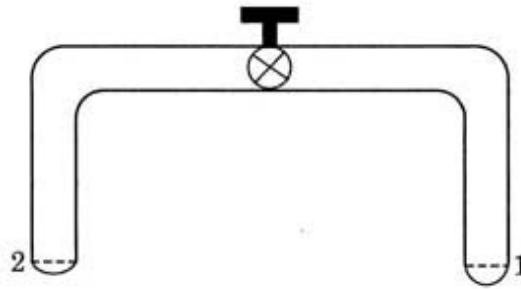

- (A) air from end 1 flows towards end 2. No change in the volume of the soap bubbles
 (B) air from end 1 flows towards end 2. Volume of the soap bubble at end 1 decreases
 (C) no change occurs
 (D) air from end 2 flows towards end 1. Volume of the soap bubble at end 1 increases

Answer

- (A)
 (B)
 (C)
 (D)

29. A vibrating string of certain length ℓ under a tension T resonates with a mode corresponding to the first overtone (third harmonic) of an air column of length 75 cm inside a tube closed at one end. The string also generates 4 beats per second when excited along with a tuning fork of frequency n . Now when the tension of the string is slightly increased the number of beats reduces to 2 per second. Assuming the velocity of sound in air to be 340 m/s, the frequency n of the tuning fork in Hz is

- (A) 344 (B) 336 (C) 117.3 (D) 109.3

Answer

- (A)
 (B)
 (C)
 (D)

30. A parallel plate capacitor C with plates of unit area and separation d is filled with a liquid of dielectric constant $K = 2$. The level of liquid is $\frac{d}{3}$ initially. Suppose the liquid level decreases at a constant speed V , the time constant as a function of time t is

Figure :

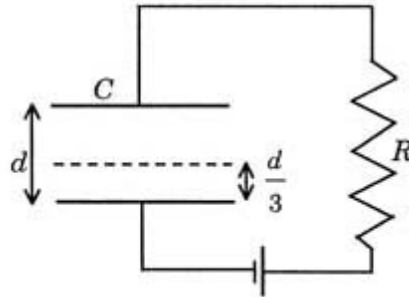

- (A) $\frac{6\epsilon_0 R}{5d + 3Vt}$ (B) $\frac{(15d + 9Vt)\epsilon_0 R}{2d^2 - 3dVt - 9V^2t^2}$
- (C) $\frac{6\epsilon_0 R}{5d - 3Vt}$ (D) $\frac{(15d - 9Vt)\epsilon_0 R}{2d^2 + 3dVt - 9V^2t^2}$

Answer

- (A) (B) (C) (D)

31. A light beam is traveling from Region I to Region IV (Refer Figure). The refractive index in Regions I, II, III and IV are $n_0, \frac{n_0}{2}, \frac{n_0}{6}$ and $\frac{n_0}{8}$, respectively. The angle of incidence θ for which the beam just misses entering Region IV is

Figure :

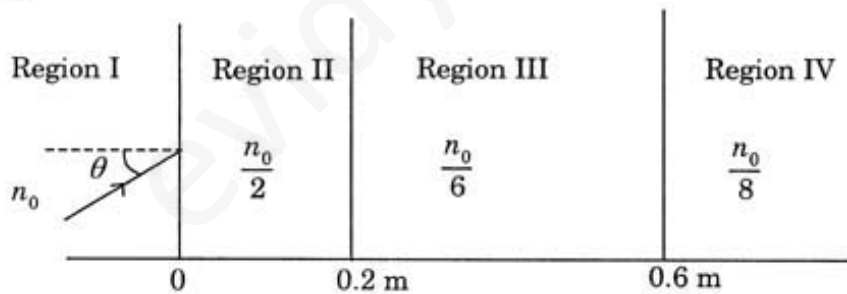

- (A) $\sin^{-1}\left(\frac{3}{4}\right)$ (B) $\sin^{-1}\left(\frac{1}{8}\right)$ (C) $\sin^{-1}\left(\frac{1}{4}\right)$ (D) $\sin^{-1}\left(\frac{1}{3}\right)$

Answer

- (A) (B) (C) (D)

32. STATEMENT-1

For an observer looking out through the window of a fast moving train, the nearby objects appear to move in the opposite direction to the train, while the distant objects appear to be stationary.

and

STATEMENT-2

If the observer and the object are moving at velocities \vec{V}_1 and \vec{V}_2 respectively with reference to a laboratory frame, the velocity of the object with respect to the observer is $\vec{V}_2 - \vec{V}_1$.

- (A) STATEMENT-1 is True, STATEMENT-2 is True; STATEMENT-2 is a correct explanation for STATEMENT-1
- (B) STATEMENT-1 is True, STATEMENT-2 is True; STATEMENT-2 is **NOT** a correct explanation for STATEMENT-1
- (C) STATEMENT-1 is True, STATEMENT-2 is False
- (D) STATEMENT-1 is False, STATEMENT-2 is True

Answer

- (A)
 (B)
 (C)
 (D)

33. STATEMENT-1

It is easier to pull a heavy object than to push it on a level ground.

and

STATEMENT-2

The magnitude of frictional force depends on the nature of the two surfaces in contact.

- (A) STATEMENT-1 is True, STATEMENT-2 is True; STATEMENT-2 is a correct explanation for STATEMENT-1
- (B) STATEMENT-1 is True, STATEMENT-2 is True; STATEMENT-2 is **NOT** a correct explanation for STATEMENT-1
- (C) STATEMENT-1 is True, STATEMENT-2 is False
- (D) STATEMENT-1 is False, STATEMENT-2 is True

Answer

- (A)
 (B)
 (C)
 (D)

34. STATEMENT-1

For practical purposes, the earth is used as a reference at zero potential in electrical circuits.

and

STATEMENT-2

The electrical potential of a sphere of radius R with charge Q uniformly distributed on the surface is given by $\frac{Q}{4\pi\epsilon_0 R}$.

- (A) STATEMENT-1 is True, STATEMENT-2 is True; STATEMENT-2 is a correct explanation for STATEMENT-1
- (B) STATEMENT-1 is True, STATEMENT-2 is True; STATEMENT-2 is **NOT** a correct explanation for STATEMENT-1
- (C) STATEMENT-1 is True, STATEMENT-2 is False
- (D) STATEMENT-1 is False, STATEMENT-2 is True

Answer

- (A)
 (B)
 (C)
 (D)

35. STATEMENT-1

The sensitivity of a moving coil galvanometer is increased by placing a suitable magnetic material as a core inside the coil.

and

STATEMENT-2

Soft iron has a high magnetic permeability and cannot be easily magnetized or demagnetized.

- (A) STATEMENT-1 is True, STATEMENT-2 is True; STATEMENT-2 is a correct explanation for STATEMENT-1
- (B) STATEMENT-1 is True, STATEMENT-2 is True; STATEMENT-2 is **NOT** a correct explanation for STATEMENT-1
- (C) STATEMENT-1 is True, STATEMENT-2 is False
- (D) STATEMENT-1 is False, STATEMENT-2 is True

Answer

- (A)
 (B)
 (C)
 (D)

Paragraph for Question Nos. 36 to 38

The nuclear charge (Ze) is non-uniformly distributed within a nucleus of radius R . The charge density $\rho(r)$ [charge per unit volume] is dependent only on the radial distance r from the centre of the nucleus as shown in figure. The electric field is only along the radial direction.

Figure :

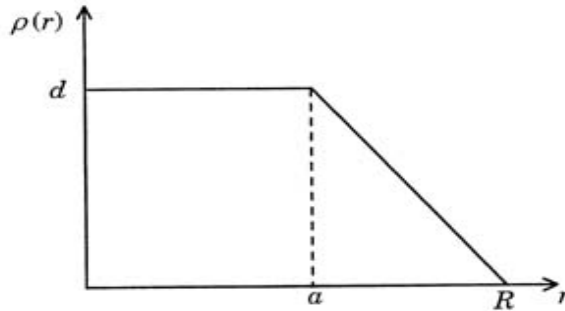

36. The electric field at $r = R$ is
 (A) independent of a (B) directly proportional to a
 (C) directly proportional to a^2 (D) inversely proportional to a

Answer

- (A) (B) (C) (D)

37. For $a = 0$, the value of d (maximum value of ρ as shown in the figure) is
 (A) $\frac{3Ze}{4\pi R^3}$ (B) $\frac{3Ze}{\pi R^3}$ (C) $\frac{4Ze}{3\pi R^3}$ (D) $\frac{Ze}{3\pi R^3}$

Answer

- (A) (B) (C) (D)

38. The electric field within the nucleus is generally observed to be linearly dependent on r . This implies
 (A) $a = 0$ (B) $a = \frac{R}{2}$ (C) $a = R$ (D) $a = \frac{2R}{3}$

Answer

- (A) (B) (C) (D)

Paragraph for Question Nos. 39 to 41

A uniform thin cylindrical disk of mass M and radius R is attached to two identical massless springs of spring constant k which are fixed to the wall as shown in the figure. The springs are attached to the axle of the disk symmetrically on either side at a distance d from its centre. The axle is massless and both the springs and the axle are in a horizontal plane. The unstretched length of each spring is L . The disk is initially at its equilibrium position with its centre of mass (CM) at a distance L from the wall. The disk rolls without slipping with velocity $\vec{V}_0 = V_0 \hat{i}$. The coefficient of friction is μ .

Figure :

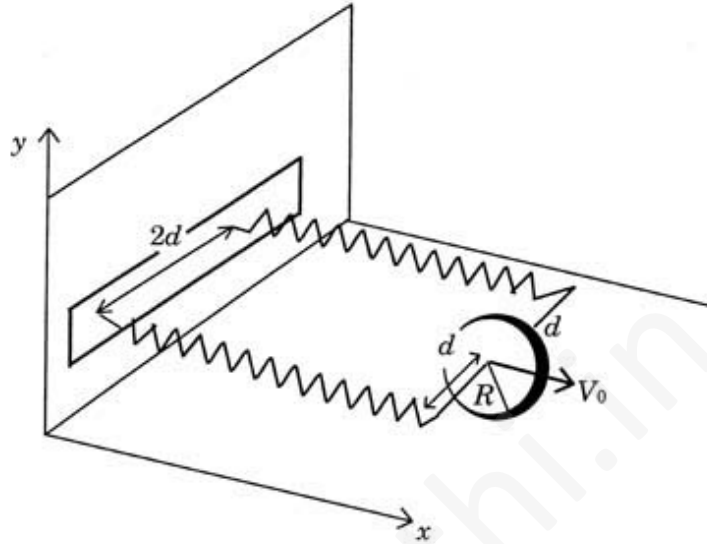

39. The net external force acting on the disk when its centre of mass is at displacement x with respect to its equilibrium position is

- (A) $-kx$ (B) $-2kx$ (C) $-\frac{2kx}{3}$ (D) $-\frac{4kx}{3}$

Answer (A) (B) (C) (D)

40. The centre of mass of the disk undergoes simple harmonic motion with angular frequency ω equal to

- (A) $\sqrt{\frac{k}{M}}$ (B) $\sqrt{\frac{2k}{M}}$ (C) $\sqrt{\frac{2k}{3M}}$ (D) $\sqrt{\frac{4k}{3M}}$

Answer (A) (B) (C) (D)

41. The maximum value of V_0 for which the disk will roll without slipping is

- (A) $\mu g \sqrt{\frac{M}{k}}$ (B) $\mu g \sqrt{\frac{M}{2k}}$ (C) $\mu g \sqrt{\frac{3M}{k}}$ (D) $\mu g \sqrt{\frac{5M}{2k}}$

Answer (A) (B) (C) (D)

Column I gives a list of possible set of parameters measured in some experiments. The variations of the parameters in the form of graphs are shown in **Column II**. Match the set of parameters given in **Column I** with the graphs given in **Column II**. Indicate your answer by darkening the appropriate bubbles of the 4×4 matrix given in the ORS.

Column I

- (A) Potential energy of a simple pendulum (y axis) as a function of displacement (x axis)
- (B) Displacement (y axis) as a function of time (x axis) for a one dimensional motion at zero or constant acceleration when the body is moving along the positive x -direction
- (C) Range of a projectile (y axis) as a function of its velocity (x axis) when projected at a fixed angle
- (D) The square of the time period (y axis) of a simple pendulum as a function of its length (x axis)

Column II

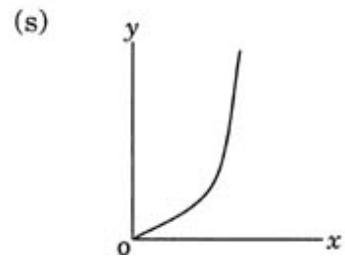
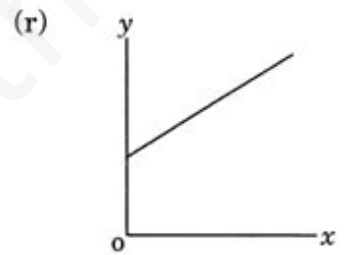
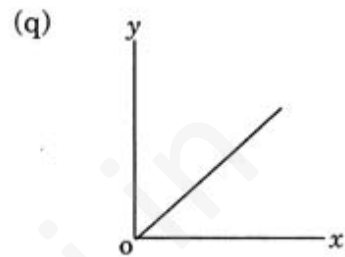
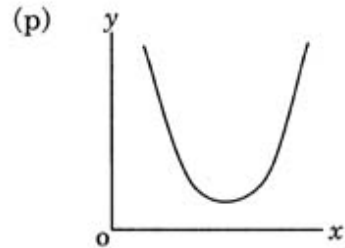

	p	q	r	s
A	<input checked="" type="radio"/>	<input type="radio"/>	<input type="radio"/>	<input checked="" type="radio"/>
B	<input type="radio"/>	<input checked="" type="radio"/>	<input checked="" type="radio"/>	<input checked="" type="radio"/>
C	<input type="radio"/>	<input type="radio"/>	<input type="radio"/>	<input checked="" type="radio"/>
D	<input type="radio"/>	<input checked="" type="radio"/>	<input type="radio"/>	<input type="radio"/>

Answer

43. An optical component and an object S placed along its optic axis are given in **Column I**. The distance between the object and the component can be varied. The properties of images are given in **Column II**. Match all the properties of images from **Column II** with the appropriate components given in **Column I**. Indicate your answer by darkening the appropriate bubbles of the 4×4 matrix given in the ORS.

Column I

Column II

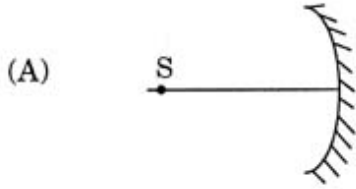

(p) Real image

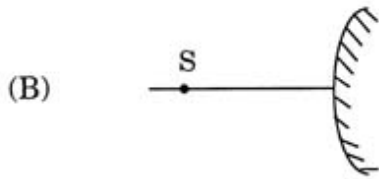

(q) Virtual image

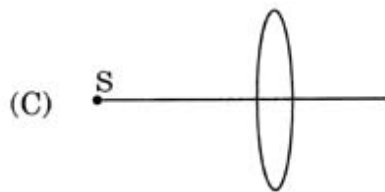

(r) Magnified image

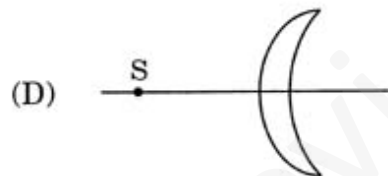

(s) Image at infinity

	p	q	r	s
A	<input checked="" type="radio"/>	<input checked="" type="radio"/>	<input checked="" type="radio"/>	<input checked="" type="radio"/>
B	<input type="radio"/>	<input checked="" type="radio"/>	<input type="radio"/>	<input type="radio"/>
C	<input checked="" type="radio"/>	<input checked="" type="radio"/>	<input checked="" type="radio"/>	<input checked="" type="radio"/>
D	<input checked="" type="radio"/>	<input checked="" type="radio"/>	<input checked="" type="radio"/>	<input checked="" type="radio"/>

Answer

44. **Column I** contains a list of processes involving expansion of an ideal gas. Match this with **Column II** describing the thermodynamic change during this process. Indicate your answer by darkening the appropriate bubbles of the 4×4 matrix given in the ORS.

Column I

- (A) An insulated container has two chambers separated by a valve. Chamber I contains an ideal gas and the Chamber II has vacuum. The valve is opened.

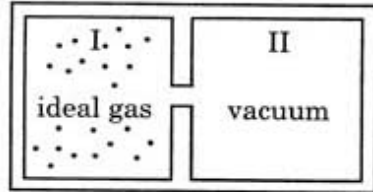

- (B) An ideal monoatomic gas expands to twice its original volume such that its pressure $P \propto \frac{1}{V^2}$, where V is the volume of the gas
- (C) An ideal monoatomic gas expands to twice its original volume such that its pressure $P \propto \frac{1}{V^{4/3}}$, where V is its volume
- (D) An ideal monoatomic gas expands such that its pressure P and volume V follows the behaviour shown in the graph

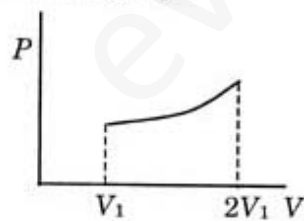

Column II

- (p) The temperature of the gas decreases
- (q) The temperature of the gas increases or remains constant
- (r) The gas loses heat
- (s) The gas gains heat

	p	q	r	s
A	<input type="radio"/>	<input checked="" type="radio"/>	<input type="radio"/>	<input type="radio"/>
B	<input checked="" type="radio"/>	<input type="radio"/>	<input checked="" type="radio"/>	<input type="radio"/>
C	<input checked="" type="radio"/>	<input type="radio"/>	<input type="radio"/>	<input checked="" type="radio"/>
D	<input type="radio"/>	<input checked="" type="radio"/>	<input type="radio"/>	<input checked="" type="radio"/>

Answer

45. The correct stability order for the following species is

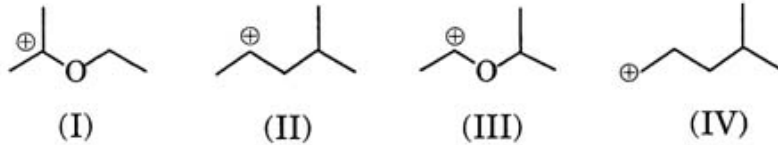

- (A) (II) > (IV) > (I) > (III) (B) (I) > (II) > (III) > (IV)
 (C) (II) > (I) > (IV) > (III) (D) (I) > (III) > (II) > (IV)

Answer (A) (B) (C) (D)

46. Cellulose upon acetylation with excess acetic anhydride/H₂SO₄ (catalytic) gives cellulose triacetate whose structure is

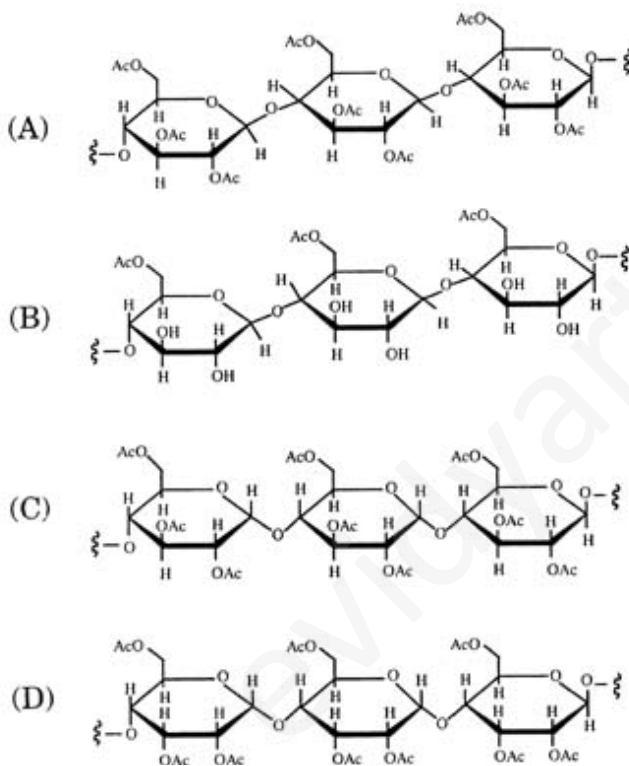

Answer (A) (B) (C) (D)

47. In the following reaction sequence, the correct structures of **E**, **F** and **G** are

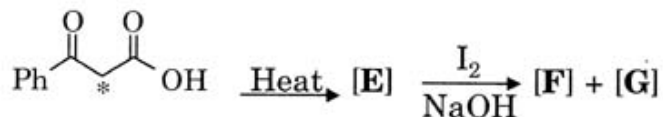

(* implies ^{13}C labelled carbon)

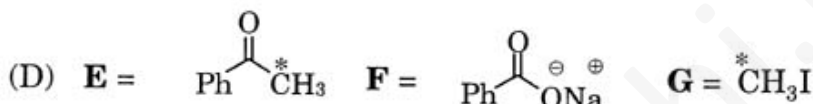
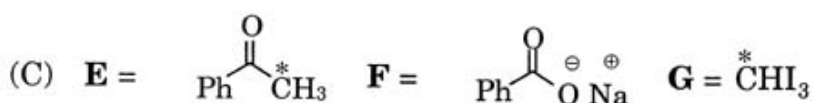
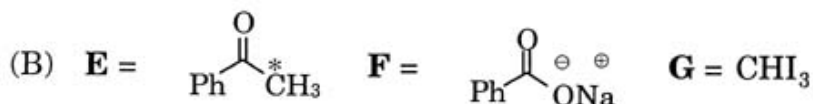
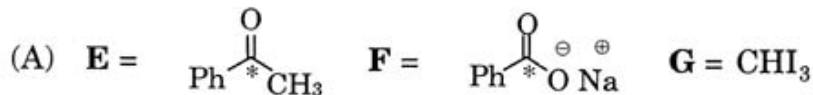

Answer

- (A) (B) (C) (D)

48. Among the following, the coloured compound is

- (A) CuCl (B) $\text{K}_3[\text{Cu}(\text{CN})_4]$
 (C) CuF_2 (D) $[\text{Cu}(\text{CH}_3\text{CN})_4]\text{BF}_4$

Answer

- (A) (B) (C) (D)

49. Both $[\text{Ni}(\text{CO})_4]$ and $[\text{Ni}(\text{CN})_4]^{2-}$ are diamagnetic. The hybridisations of nickel in these complexes, respectively, are

- (A) sp^3, sp^3 (B) sp^3, dsp^2 (C) dsp^2, sp^3 (D) dsp^2, dsp^2

Answer

- (A) (B) (C) (D)

50. The IUPAC name of $[\text{Ni}(\text{NH}_3)_4][\text{NiCl}_4]$ is

- (A) Tetrachloronickel (II) - tetraamminenickel (II)
 (B) Tetraamminenickel (II) - tetrachloronickel (II)
 (C) Tetraamminenickel (II) - tetrachloronickelate (II)
 (D) Tetrachloronickel (II) - tetraamminenickelate (II)

Answer

- (A) (B) (C) (D)

51. Electrolysis of dilute aqueous NaCl solution was carried out by passing 10 milli ampere current. The time required to liberate 0.01 mol of H_2 gas at the cathode is (1 Faraday = 96500 C mol^{-1})

- (A) $9.65 \times 10^4 \text{ sec}$ (B) $19.3 \times 10^4 \text{ sec}$
 (C) $28.95 \times 10^4 \text{ sec}$ (D) $38.6 \times 10^4 \text{ sec}$

Answer

- (A) (B) (C) (D)

52. Among the following, the surfactant that will form micelles in aqueous solution at the lowest molar concentration at ambient conditions is

- (A) $\text{CH}_3(\text{CH}_2)_{15}\text{N}^+(\text{CH}_3)_3\text{Br}^-$ (B) $\text{CH}_3(\text{CH}_2)_{11}\text{OSO}_3^- \text{Na}^+$
 (C) $\text{CH}_3(\text{CH}_2)_6\text{COO}^- \text{Na}^+$ (D) $\text{CH}_3(\text{CH}_2)_{11}\text{N}^+(\text{CH}_3)_3\text{Br}^-$

Answer

- (A) (B) (C) (D)

53. Solubility product constants (K_{sp}) of salts of types MX , MX_2 and M_3X at temperature 'T' are 4.0×10^{-8} , 3.2×10^{-14} and 2.7×10^{-15} , respectively. Solubilities (mol dm^{-3}) of the salts at temperature 'T' are in the order

- (A) $\text{MX} > \text{MX}_2 > \text{M}_3\text{X}$ (B) $\text{M}_3\text{X} > \text{MX}_2 > \text{MX}$
 (C) $\text{MX}_2 > \text{M}_3\text{X} > \text{MX}$ (D) $\text{MX} > \text{M}_3\text{X} > \text{MX}_2$

Answer

- (A) (B) (C) (D)

54. STATEMENT-1 : Aniline on reaction with NaNO_2/HCl at 0°C followed by coupling with β -naphthol gives a dark blue coloured precipitate.

and

STATEMENT-2 : The colour of the compound formed in the reaction of aniline with NaNO_2/HCl at 0°C followed by coupling with β -naphthol is due to the extended conjugation.

- (A) STATEMENT-1 is True, STATEMENT-2 is True; STATEMENT-2 is a correct explanation for STATEMENT-1
- (B) STATEMENT-1 is True, STATEMENT-2 is True; STATEMENT-2 is NOT a correct explanation for STATEMENT-1
- (C) STATEMENT-1 is True, STATEMENT-2 is False
- (D) STATEMENT-1 is False, STATEMENT-2 is True

Answer

- (A) (B) (C) (D)

55. STATEMENT-1 : $[\text{Fe}(\text{H}_2\text{O})_5\text{NO}]\text{SO}_4$ is paramagnetic.

and

STATEMENT-2 : The Fe in $[\text{Fe}(\text{H}_2\text{O})_5\text{NO}]\text{SO}_4$ has three unpaired electrons.

- (A) STATEMENT-1 is True, STATEMENT-2 is True; STATEMENT-2 is a correct explanation for STATEMENT-1
- (B) STATEMENT-1 is True, STATEMENT-2 is True; STATEMENT-2 is NOT a correct explanation for STATEMENT-1
- (C) STATEMENT-1 is True, STATEMENT-2 is False
- (D) STATEMENT-1 is False, STATEMENT-2 is True

Answer

- (A) (B) (C) (D)

56. STATEMENT-1 : The geometrical isomers of the complex $[\text{M}(\text{NH}_3)_4\text{Cl}_2]$ are optically inactive.

and

STATEMENT-2 : Both geometrical isomers of the complex $[\text{M}(\text{NH}_3)_4\text{Cl}_2]$ possess axis of symmetry.

- (A) STATEMENT-1 is True, STATEMENT-2 is True; STATEMENT-2 is a correct explanation for STATEMENT-1
- (B) STATEMENT-1 is True, STATEMENT-2 is True; STATEMENT-2 is NOT a correct explanation for STATEMENT-1
- (C) STATEMENT-1 is True, STATEMENT-2 is False
- (D) STATEMENT-1 is False, STATEMENT-2 is True

Answer

- (A) (B) (C) (D)

57. STATEMENT-1 : There is a natural asymmetry between converting work to heat and converting heat to work.

and

STATEMENT-2 : No process is possible in which the sole result is the absorption of heat from a reservoir and its complete conversion into work.

- (A) STATEMENT-1 is True, STATEMENT-2 is True; STATEMENT-2 is a correct explanation for STATEMENT-1
- (B) STATEMENT-1 is True, STATEMENT-2 is True; STATEMENT-2 is **NOT** a correct explanation for STATEMENT-1
- (C) STATEMENT-1 is True, STATEMENT-2 is False
- (D) STATEMENT-1 is False, STATEMENT-2 is True

Answer

- (A) (B) (C) (D)

Paragraph for Question Nos. 58 to 60

A tertiary alcohol **H** upon acid catalysed dehydration gives a product **I**. Ozonolysis of **I** leads to compounds **J** and **K**. Compound **J** upon reaction with KOH gives benzyl alcohol and a compound **L**, whereas **K** on reaction with KOH gives only **M**.

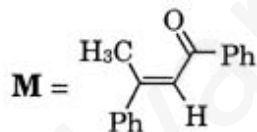

58. Compound **H** is formed by the reaction of

- (A) $\text{Ph}-\overset{\text{O}}{\parallel}-\text{CH}_3 + \text{PhMgBr}$
- (B) $\text{Ph}-\overset{\text{O}}{\parallel}-\text{CH}_3 + \text{PhCH}_2\text{MgBr}$
- (C) $\text{Ph}-\overset{\text{O}}{\parallel}-\text{H} + \text{PhCH}_2\text{MgBr}$
- (D) $\text{Ph}-\overset{\text{O}}{\parallel}-\text{H} + \text{Ph}-\overset{\text{Me}}{\text{C}}-\text{MgBr}$

Answer

- (A) (B) (C) (D)

59. The structure of compound **I** is

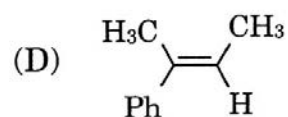
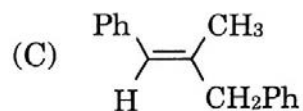
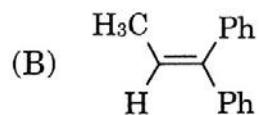
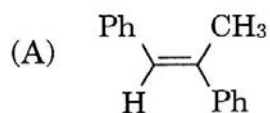

Answer

- (A)
 (B)
 (C)
 (D)

60. The structures of compounds **J**, **K** and **L**, respectively, are

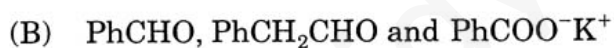

Answer

- (A)
 (B)
 (C)
 (D)

Paragraph for Question Nos. 61 to 63

In hexagonal systems of crystals, a frequently encountered arrangement of atoms is described as a hexagonal prism. Here, the top and bottom of the cell are regular hexagons and three atoms are sandwiched in between them. A space-filling model of this structure, called hexagonal close-packed (HCP), is constituted of a sphere on a flat surface surrounded in the same plane by six identical spheres as closely as possible. Three spheres are then placed over the first layer so that they touch each other and represent the second layer. Each one of these three spheres touches three spheres of the bottom layer. Finally, the second layer is covered with a third layer that is identical to the bottom layer in relative position. Assume radius of every sphere to be 'r'.

61. The number of atoms in this HCP unit cell is

- (A) 4 (B) 6 (C) 12 (D) 17

- (A) (B) (C) (D)

Answer

62. The volume of this HCP unit cell is

- (A) $24\sqrt{2}r^3$ (B) $16\sqrt{2}r^3$ (C) $12\sqrt{2}r^3$ (D) $\frac{64}{3\sqrt{3}}r^3$

- (A) (B) (C) (D)

Answer

63. The empty space in this HCP unit cell is

- (A) 74% (B) 47.6% (C) 32% (D) 26%

- (A) (B) (C) (D)

Answer

64. Match the compounds in **Column I** with their characteristic test(s)/reaction(s) given in **Column II**. Indicate your answer by darkening the appropriate bubbles of the 4×4 matrix given in the ORS.

Column I

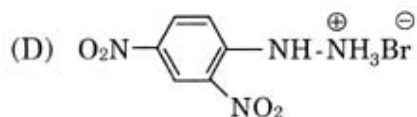
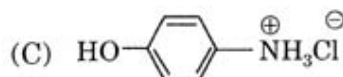
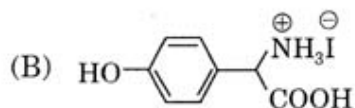
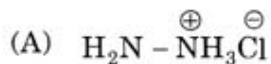

Column II

(p) sodium fusion extract of the compound gives Prussian blue colour with FeSO_4

(q) gives positive FeCl_3 test

(r) gives white precipitate with AgNO_3

(s) reacts with aldehydes to form the corresponding hydrazone derivative

	p	q	r	s
A	<input type="radio"/>	<input type="radio"/>	<input checked="" type="radio"/>	<input type="radio"/>
B	<input checked="" type="radio"/>	<input checked="" type="radio"/>	<input type="radio"/>	<input type="radio"/>
C	<input checked="" type="radio"/>	<input checked="" type="radio"/>	<input checked="" type="radio"/>	<input type="radio"/>
D	<input checked="" type="radio"/>	<input type="radio"/>	<input type="radio"/>	<input type="radio"/>

OR

	p	q	r	s
A	<input type="radio"/>	<input type="radio"/>	<input checked="" type="radio"/>	<input checked="" type="radio"/>
B	<input checked="" type="radio"/>	<input checked="" type="radio"/>	<input type="radio"/>	<input type="radio"/>
C	<input checked="" type="radio"/>	<input checked="" type="radio"/>	<input checked="" type="radio"/>	<input type="radio"/>
D	<input checked="" type="radio"/>	<input type="radio"/>	<input type="radio"/>	<input checked="" type="radio"/>

Answer

65. Match the conversions in **Column I** with the type(s) of reaction(s) given in **Column II**. Indicate your answer by darkening the appropriate bubbles of the 4×4 matrix given in the ORS

Column I

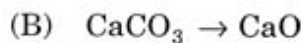
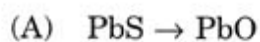

Column II

(p) roasting

(q) calcination

(r) carbon reduction

(s) self reduction

	p	q	r	s
A	<input checked="" type="radio"/>	<input type="radio"/>	<input type="radio"/>	<input type="radio"/>
B	<input type="radio"/>	<input checked="" type="radio"/>	<input type="radio"/>	<input type="radio"/>
C	<input checked="" type="radio"/>	<input type="radio"/>	<input checked="" type="radio"/>	<input type="radio"/>
D	<input checked="" type="radio"/>	<input type="radio"/>	<input type="radio"/>	<input checked="" type="radio"/>

Answer

66. Match the entries in **Column I** with the correctly related quantum number(s) in **Column II**. Indicate your answer by darkening the appropriate bubbles of the 4×4 matrix given in the ORS

Column I

(A) Orbital angular momentum of the electron in a hydrogen-like atomic orbital

(B) A hydrogen-like one-electron wave function obeying Pauli principle

(C) Shape, size and orientation of hydrogen-like atomic orbitals

(D) Probability density of electron at the nucleus in hydrogen-like atom

Column II

(p) Principal quantum number

(q) Azimuthal quantum number

(r) Magnetic quantum number

(s) Electron spin quantum number

	p	q	r	s
A	<input type="radio"/>	<input checked="" type="radio"/>	<input checked="" type="radio"/>	<input type="radio"/>
B	<input checked="" type="radio"/>	<input checked="" type="radio"/>	<input checked="" type="radio"/>	<input checked="" type="radio"/>
C	<input checked="" type="radio"/>	<input checked="" type="radio"/>	<input checked="" type="radio"/>	<input type="radio"/>
D	<input checked="" type="radio"/>	<input checked="" type="radio"/>	<input type="radio"/>	<input type="radio"/>

Answer