

AIPMT

SAMPLE PAPERS WITH SOLUTIONS

1. The cells lining the blood vessels belong to the category of
- (1) Columnar epithelium
 - (2) Connective tissue
 - (3) Smooth muscle tissue
 - (4) Squamous epithelium

Ans. (4)

Sol. Simple squamous epithelium is present where diffusion and filtration is required. Cells lining our blood vessels belong to the category of simple squamous epithelium.

2. Consider the following statements (A-D) about organic farming
- A. Utilizes genetically modified crops like Bt cotton
 - B. Uses only naturally produced inputs like compost
 - C. Does not use pesticides and urea
 - D. Produces vegetables rich in vitamins and minerals

Which of the above statements are correct?

- (1) (B) and (C) only
- (2) (A) and (B) only
- (3) (B), (C) and (D)
- (4) (C) and (D) only

Ans. (1)

Sol. Organic farming is a zero waste cyclical procedure, where waste from one process are cycled in as nutrient for other process.

3. Select the **correct** statement with respect to diseases and immunisation

- (1) Certain protozoans have been used to mass produce hepatitis B vaccine
- (2) Injection of snake antivenom against snake bite is an example of active immunisation
- (3) If due to some reason B-and T-lymphocytes are damaged, the body will not produce antibodies against a pathogen
- (4) Injection of dead / inactivated pathogens causes passive immunity

Ans. (3)

Sol. Clone of B-cells is called as plasma cells which produce antibodies. Helper T-cells secrete IL-2 (interleukin-2) which stimulate B cells to produce antibodies. Injection of snake antivenom against snake bite is an example of artificially acquired passive immunity.

4. *Selaginella* and *Salvinia* are considered to represent a significant step toward evolution of seed habit because

- (1) Megaspores possess endosperm and embryo surrounded by seed coat
- (2) Embryo develops in female gametophyte which is retained on parent sporophyte
- (3) Female gametophyte is free and gets dispersed like seeds
- (4) Female gametophyte lacks archegonia

Ans. (2)

Sol. Both are heterosporous genera; archegonia are present in both cases.

13. Three of the following pairs of the human skeletal parts are correctly matched with their respective inclusive skeletal category and one pair is not matched. Identify the **non-matching** pair.

	Pairs of skeletal parts	Category
(1)	Humerus and ulna	Appendicular skeleton
(2)	Malleus and stapes	Ear ossicles
(3)	Sternum and Ribs	Axial skeleton
(4)	Clavicle and Glenoid cavity	Pelvic girdle

Ans. (4)

Sol. Clavicle and glenoid cavity are a part of pectoral girdle.

14. What is common between vegetative reproduction and Apomixis?

- (1) Both occur round the year
- (2) Both produces progeny identical to the parent
- (3) Both are applicable to only dicot plants
- (4) Both bypass the flowering phase

Ans. (2)

Sol. Both processes do not involves meiosis and syngamy.

15. Read the following statement having two blanks (A and B)

"A drug used for ___(A)___ patients is obtained from a species of the organism ___(B)___."

The one **correct** option for the two blanks is

Blank-A

- (1) Swine flu
- (2) AIDS
- (3) Heart
- (4) Organ-transplant

Blank-B

- (1) *Monascus*
- (2) *Pseudomonas*
- (3) *Penicillium*
- (4) *Trichoderma*

Ans. (4)

Sol. Cyclosporin drug is obtained from the fungus *Trichoderma* and is used in organ-transplantation.

16. Which one of the following conditions of the zygotic cell would lead to the birth of a normal human female child?

- (1) Only one X chromosome
- (2) One X and one Y chromosome
- (3) Two X chromosome
- (4) Only one Y chromosome

Ans. (3)

Sol. In human female

$$2n = 46$$

$$= 44 + XX$$

17. The 24 hour (diurnal) rhythm of our body such as the sleep-wake cycle is regulated by the hormone.

- (1) Adrenaline
- (2) Melatonin
- (3) Calcitonin
- (4) Prolactin

Ans. (2)

Sol. The 24 hour (diurnal) rhythm of our body such as the sleep wake cycle is regulated by melatonin hormone.

18. Which one of the following pairs is **wrongly** matched while the remaining three are correct?

- (1) *Bryophyllum* – Leaf buds
- (2) *Agave* – Bulbils
- (3) *Penicillium* – Conidia
- (4) Water hyacinth – Runner

Ans. (4)

Sol. Water hyacinth – Offset.

19. Function of companion cells is

- (1) Loading of sucrose into sieve elements by passive transport
- (2) Loading of sucrose into sieve elements
- (3) Providing energy to sieve elements for active transport
- (4) Providing water to phloem

Ans. (2)

Sol. Companion cell maintains pressure gradient in sieves.

20. Which one of the following is **not** considered as a part of the endomembrane system?

- (1) Vacuole
- (2) Lysosome
- (3) Golgi complex
- (4) Peroxisome

Ans. (4)

Sol. Endomembrane system involves – Golgi, ER, vacuole and lysosome.

21. In Kranz anatomy, the bundle sheath cells have

- (1) Thin walls, no intercellular spaces and several chloroplasts
- (2) Thick walls, many intercellular spaces and few chloroplasts
- (3) Thin walls, many intercellular spaces and no chloroplasts
- (4) Thick walls, no intercellular spaces and large number of chloroplasts

Ans. (4)

Sol. Thin walls with few chloroplast is character of mesophyll cells in C_4 plants.

22. Sweet potato is homologous to

- (1) Ginger
- (2) Turnip
- (3) Potato
- (4) Colocasia

Ans. (2)

Sol. Turnip – Modified tap root for food storage.

Sweet potato – Modified adventitious root for food storage.

23. Ureters act as urinogenital ducts in

- (1) Frog's both males and females
- (2) Frog's males
- (3) Human males
- (4) Human females

Ans. (2)

Sol. Ureters act as urinogenital duct in male frog. In human beings urethra acts as male urinogenital duct.

24. Which one of the following is a possibility for most of us in regard to breathing, by making a *conscious effort*?

- (1) One can consciously breathe in and breathe out by moving the diaphragm alone, without moving the ribs at all
- (2) The lungs can be made fully empty by forcefully breathing out all air from them
- (3) One can breathe out air totally without oxygen
- (4) One can breathe out air through eustachian tubes by closing both the nose and the mouth

Ans. (1)

25. Read the following four statements (A-D) about certain mistakes in two of them

- (A) The first transgenic buffalo Rosie produced milk which was human alpha-lactalbumin enriched
- (B) Restriction enzymes are used in isolation of DNA from other macro-molecules
- (C) Downstream processing is one of the steps of R-DNA technology
- (D) Disarmed pathogen vectors are also used in transfer of R-DNA into the host

Which are the two statements having mistakes?

- (1) Statements (A) and (C)
- (2) Statements (A) and (B)
- (3) Statements (B) and (C)
- (4) Statements (C) and (D)

Ans. (2)

Sol. In statement A, the first transgenic cow was named as Rosie. In Statement B, Restriction endonucleases are used for cutting the DNA at specific points.

26. The pathogen *Microsporium* responsible for ringworm disease in humans belongs to the same Kingdom of organisms as that of

- (1) *Rhizopus*, a mould
- (2) *Ascaris*, a round worm
- (3) *Taenia*, a tapeworm
- (4) *Wuchereria*, a filarial worm

Ans. (1)

Sol. *Microsporium* which causes ringworm disease is a fungus.

27. Which one of the following techniques made it possible to genetically engineer living organisms?

- (1) Heavier isotope labelling
- (2) Hybridization
- (3) Recombinant DNA techniques
- (4) X-ray diffraction

Ans. (3)

28. "Good ozone" is found in the

- (1) Stratosphere
- (2) Ionosphere
- (3) Mesosphere
- (4) Troposphere

Ans. (1)

Sol. Tropospheric ozone is bad ozone.

29. Guttation is the result of

- (1) Osmosis
- (2) Root pressure
- (3) Diffusion
- (4) Transpiration

Ans. (2)

Sol. Root pressure leads to both guttation and bleeding.

30. Biodiversity of a geographical region represents

- (1) Genetic diversity present in the dominant species of the region
- (2) Species endemic to the region
- (3) Endangered species found in the region
- (4) The diversity in the organisms living in the region

Ans. (4)

Sol. Biodiversity represents the sum total of variations in all components of biosphere.

31. At metaphase, chromosomes are attached to the spindle fibres by their

- (1) Kinetochores
- (2) Centromere
- (3) Satellites
- (4) Secondary constrictions

Ans. (1)

Sol. Kinetochore-site of attachment of spindles.

32. Which one of the following is a wrong matching of a microbe and its industrial product, while the remaining three are correct?

- (1) *Clostridium butylicum* - lactic acid
- (2) *Aspergillus niger* - citric acid
- (3) Yeast - statins
- (4) *Acetobacter aceti* - acetic acid

Ans. (1)

Sol. *Clostridium butylicum*- Butyric acid.

33. Silencing of mRNA has been used in producing transgenic plants resistant to

- (1) White rusts
- (2) Bacterial blights
- (3) Bollworms
- (4) Nematodes

Ans. (4)

Sol. Silencing of m-RNA has been used in producing transgenic plants resistant to nematoda, *Meloidogyne incognita*.

34. Which one of the following statements is **totally wrong** about the occurrence of notochord while the other three are correct

- (1) It is absent throughout life in humans from the very beginning
- (2) It is present throughout life in *Amphioxus*
- (3) It is present only in larval tail in *Ascidians*
- (4) It is replaced by a vertebral column in adult frog

Ans. (1)

Sol. Notochord is present in the embryonic development of all chordates but in vertebrates it is replaced by vertebral column.

35. The technique called gamete intrafallopian transfer (GIFT) is recommended for those females

- (1) Whose cervical canal is too narrow to allow passage for the sperms
- (2) Who cannot provide suitable environment for fertilisation
- (3) Who cannot produce an ovum
- (4) Who cannot retain the foetus inside uterus

Ans. (3)

Sol. GIFT is gamete intrafallopian transfer. In this gametes are transferred into the fallopian tube of females.

36. Common cold is not cured by antibiotics because it is

- (1) Caused by a Gram-negative bacterium
- (2) Not an infectious disease
- (3) Caused by a virus
- (4) Caused by a Gram-positive bacterium

Ans. (3)

Sol. Common cold is not cured by antibiotics because it is caused by virus. Viral diseases cannot be treated by antibiotics as they lack cell wall.

37. Which one of the following options gives the **correct** matching of a disease with its causative organism and mode of infection

Disease	Causative Organisms	Mode of Infection
(1) Elephantiasis	<i>Wuchereria bancrofti</i>	With infected water and food
(2) Malaria	<i>Plasmodium vivax</i>	Bite of male <i>Anopheles</i> mosquito
(3) Typhoid	<i>Salmonella typhi</i>	With inspired air
(4) Pneumonia	<i>Streptococcus Pneumoniae</i>	Droplet infection

Ans. (4)

38. Frogs differ from humans in possessing

- (1) Nucleated red blood cells
- (2) Thyroid as well as parathyroid
- (3) Paired cerebral hemispheres
- (4) Hepatic portal system

Ans. (1)

39. Test cross in plants or in *Drosophila* involves crossing

- (1) The F_1 hybrid with a double recessive genotype
- (2) Between two genotypes with dominant trait
- (3) Between two genotypes with recessive trait
- (4) Between two F_1 hybrids

Ans. (1)

Sol. F_1 , crossed with pure recessive parent, like

$$Tt \times tt / TtRr \times ttrr$$

40. The logistic population growth is expressed by the equation

- (1) $dN/dt = rN$
- (2) $dN/dt = rN \left(\frac{N-K}{N} \right)$
- (3) $dt/dN = Nr \left(\frac{K-N}{K} \right)$
- (4) $dN/dt = rN \left(\frac{K-N}{K} \right)$

Ans. (4)

Sol. $\frac{dN}{dt} = rN$ explains exponential growth.

41. Examine the figure given below and select the right option giving all the four parts (a, b, c, d) correctly identified

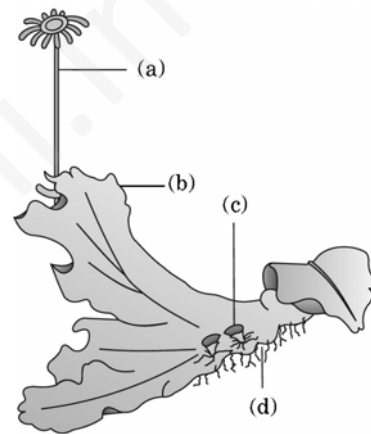

A	B	C	D
(1) Seta	Sporophyte	Protonema	Rhizoids
(2) Antherid-iophore	Male thallus	Globule	Roots
(3) Archegoniophore	Female thallus	Gemma-cup	Rhizoids
(4) Archegoniophore	Female thallus	Bud	Foot

Ans. (3)

Sol. Female plant of *Marchantia* is given.

42. About which day in a normal human menstrual cycle does rapid secretion of LH (Popularly called LH-surge) normally occurs

- (1) 5th day
- (2) 11th day
- (3) 14th day
- (4) 20th day

Ans. (3)

43. In history of biology, human genome project led to the development of?

- (1) Bioinformatics
- (2) Biosystematics
- (3) Biotechnology
- (4) Biomonitoring

Ans. (1)

Sol. HGP was closely associated with the rapid development of a new area in biology called as bioinformatics.

44. Which one of the following correctly represents the normal adult human dental formula?

- (1) $\frac{2}{2}, \frac{1}{1}, \frac{2}{2}, \frac{3}{3}$ (2) $\frac{3}{3}, \frac{1}{1}, \frac{3}{3}, \frac{3}{3}$
(3) $\frac{3}{3}, \frac{1}{1}, \frac{3}{2}, \frac{1}{1}$ (4) $\frac{2}{2}, \frac{1}{1}, \frac{3}{2}, \frac{3}{3}$

Ans. (1)

Sol. Dental formula of adult human is $\frac{2123}{2123}$.

45. The type of muscles present in our

- (1) *Thigh* are striated and voluntary
(2) *Upper arm* are smooth muscle fibres fusiform in shape
(3) *Heart* are involuntary and unstriated smooth muscles
(4) *Intestine* are striated and involuntary

Ans. (1)

Sol. The type of muscles present in our thigh are striated/voluntary/skeletal.

46. Which one of the following is not an essential mineral element for plants while the remaining three are?

- (1) Cadmium (2) Phosphorus
(3) Iron (4) Manganese

Ans. (1)

Sol. Cadmium- non essential element, heavy metal causing itai-itai disease.

47. Consider the following four statements whether they are correct or wrong?

- (A) The sporophyte in liverworts is more elaborate than that in mosses
(B) *Salvinia* is heterosporous
(C) The life-cycle in all seed bearing plants is diplontic
(D) In *Pinus* male and female cones are borne on different trees

The two *wrong* statements together are

- (1) Statements (B) and (C)
(2) Statements (A) and (B)
(3) Statements (A) and (C)
(4) Statements (A) and (D)

Ans. (4)

Sol. Sporophyte is more elaborate in mosses as compared to liverworts; *Pinus* is a monoecious plant.

48. Consider the following four statements (A-D) related to the common frog *Rana tigrina*, and select the correct option stating which ones are true (T) and which ones are false (F).

Statements:

- (A) One dry land it would die due to lack of O₂ if its mouth is forcibly kept closed for a few days.
(B) It has four chambered heart.
(C) On dry land it turns uricotelic from ureotelic.
(D) Its life history is carried out in pond water.

Options :

- | | (A) | (B) | (C) | (D) |
|-----|-----|-----|-----|-----|
| (1) | F | F | T | T |
| (2) | F | T | T | F |
| (3) | T | F | F | T |
| (4) | T | T | F | F |

Ans. (1)

49. The figure shows four animals (a), (b), (c) and (d). Select the correct answer with respect to a common characteristics of two of these animals.

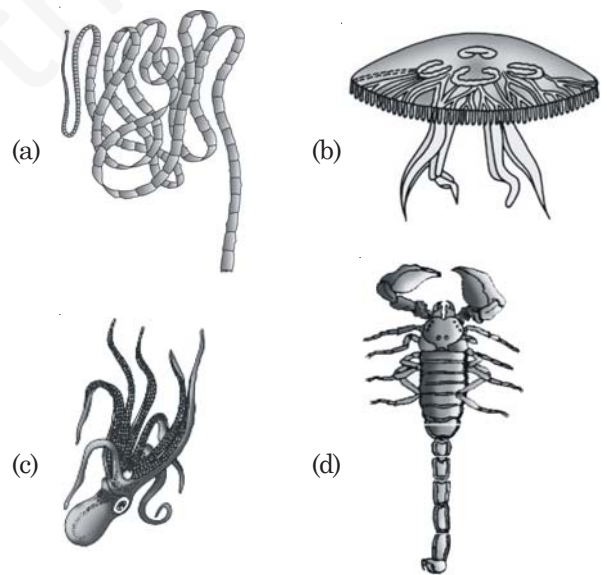

- (1) (a) and (d) have cnidoblasts for self-defence
(2) (c) and (d) have a true coelom
(3) (a) and (d) respire mainly through body wall
(4) (b) and (c) show radial symmetry

Ans. (2)

50. In angiosperms, functional megaspore develops into

- (1) Endosperm (2) Pollen sac
(3) Embryo sac (4) Ovule

Ans. (3)

Sol. Megaspore develops into female gametophyte (embryo sac) in angiosperms.

51. Which one of the following aspects is an exclusive characteristic of living things?

- (1) Perception of events happening in the environment and their memory
- (2) Increase in mass by accumulation of material both on surface as well as internally
- (3) Isolated metabolic reactions occur *in vitro*
- (4) Increase in mass from inside only

Ans. (1)

Sol. Consciousness/irritability is most obvious complicated and technical character of living beings.

52. Some vascular bundles are described as open because these

- (1) Possess conjunctive tissue between xylem and phloem
- (2) Are not surrounded by pericycle
- (3) Are surrounded by pericycle but no endodermis
- (4) Are capable of producing secondary xylem and phloem

Ans. (4)

Sol. Intrafascicular cambium is present between xylem and phloem in dicot stem bundles.

53. *Bacillus thuringiensis* forms protein crystals which contain insecticidal protein.

This protein :

- (1) Is activated by acid pH of the foregut of the insect pest
- (2) Does not kill the carrier bacterium which is itself resistant to this toxin
- (3) Binds with epithelial cells of midgut of the insect pest ultimately killing it
- (4) Is coded by several genes including the gene *cry*

Ans. (3)

Sol. Bt toxins can bind with the mid gut epithelium of the insect pest and create pores killing it.

54. One of the constituents of the pancreatic juice while poured into the duodenum in humans is

- (1) Trypsin
- (2) Enterokinase
- (3) Trypsinogen
- (4) Chymotrypsin

Ans. (3)

55. Which one of the following structures in *Pheretima* is correctly matched with its function?

- (1) Setae-defence against predators
- (2) Typhlosole - storage of extra nutrients
- (3) Clitellum - secretes cocoon
- (4) Gizzard - absorbs digested food

Ans. (3)

56. Both, hydrarch and xerarch successions lead to

- (1) Highly dry conditions
- (2) Excessive wet conditions
- (3) Medium water conditions
- (4) Xeric conditions

Ans. (3)

Sol. Both successional events leads to mesic climate.

57. The breakdown of detritus into smaller particles by earthworm is a process called

- (1) Mineralisation
- (2) Catabolism
- (3) Humification
- (4) Fragmentation

Ans. (4)

Sol. Others are performed by heterotrophic microbes.

58. Which one of the following diagrams represents the placentation in *Dianthus*?

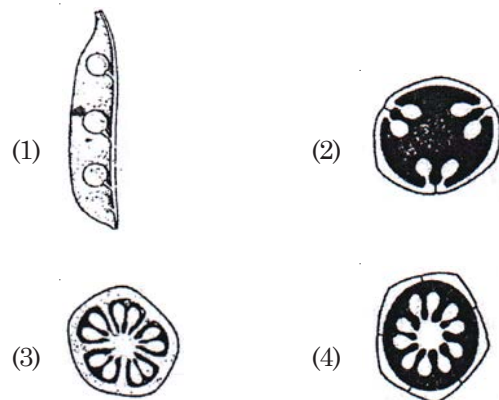

Ans. (4)

Sol. Free central placentation.

59. The figure below shows the structure of a mitochondrion with its four parts labelled (A), (B), (C) and (D). Select the part correctly matched with its function.

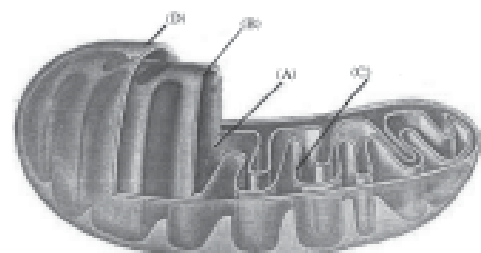

- (1) Part (C) : Cristae – possess single circular DNA molecule and ribosomes
- (2) Part (A) : Matrix – major site for respiratory chain enzymes
- (3) Part (D) : Outer membrane – gives rise to inner membrane by splitting
- (4) Part (B) : Inner membrane – forms infoldings called cristae

Ans. (4)

Sol. Circular DNA and 70 S ribosomes are present in matrix.

60. Consider the following statement (A)-(D) each with one or two blanks.

- (A) Bears go into _____ (1) _____ during winter to _____ (2) _____ cold weather
- (B) A conical age pyramid with a broad base represents _____ (3) _____ human population
- (C) A wasp pollinating a fig flower is an example of _____ (4) _____
- (D) An area with high levels of species richness is known as _____ (5) _____

Which one of the following options, gives the correct fill ups for the respective **blank numbers** from (1) to (5) in the statements?

- (1) (3) - expanding, (4) - commensalism, (5) - biodiversity park
- (2) (1) - hibernation, (2) - escape, (3) - expanding, (5) - hot spot
- (3) (3) - stable, (4) - commensalism, (5) - marsh
- (4) (1) - aestivation, (2) - escape, (3) - stable, (4) - mutualism

Ans. (2)

Sol. Hibernation - winter sleep; triangular pyramid shows positive growth.

61. A galvanometer of resistance, G is shunted by a resistance S ohm. To keep the main current in the circuit unchanged, the resistance to be put in series with the galvanometer is

- (1) $\frac{G^2}{(S+G)}$ (2) $\frac{G}{(S+G)}$
- (3) $\frac{S^2}{(S+G)}$ (4) $\frac{SG}{(S+G)}$

Ans. (1)

Sol. $G = \frac{GS}{G+S} + R$

$\therefore R = \frac{G^2}{S+G}$

62. A particle covers half of its total distance with speed v_1 and the rest half distance with speed v_2 . Its average speed during the complete journey is

- (1) $\frac{v_1^2 v_2^2}{v_1^2 + v_2^2}$ (2) $\frac{v_1 + v_2}{2}$
- (3) $\frac{v_1 v_2}{v_1 + v_2}$ (4) $\frac{2v_1 v_2}{v_1 + v_2}$

Ans. (4)

Sol. $\frac{2S}{\frac{S}{V_1} + \frac{S}{V_2}} = \frac{2V_1 V_2}{V_1 + V_2}$

63. A thermocouple of negligible resistance produces an e.m.f. of $40 \mu\text{V}/^\circ\text{C}$ in the linear range of temperature. A galvanometer of resistance 10 ohm whose sensitivity is $1 \mu\text{A}/\text{div}$, is employed with the thermocouple. The smallest value of temperature difference that can be detected by the system will be

- (1) 0.1°C (2) 0.25°C
- (3) 0.5°C (4) 1°C

Ans. (2)

Sol. $\frac{1\mu\text{A}}{\text{div}} \times 10 \text{ ohm} = 0.25^\circ\text{C}$

64. A mass m moving horizontally (along the x -axis) with velocity v collides and sticks to a mass of $3m$ moving vertically upward (along the y -axis) with velocity $2v$. The final velocity of the combination is

- (1) $\frac{2}{3}v\hat{i} + \frac{1}{3}v\hat{j}$ (2) $\frac{3}{2}v\hat{i} + \frac{1}{4}v\hat{j}$
- (3) $\frac{1}{4}v\hat{i} + \frac{3}{2}v\hat{j}$ (4) $\frac{1}{3}v\hat{i} + \frac{2}{3}v\hat{j}$

Ans. (3)

Sol. $\frac{mv\hat{i} + 3m2v\hat{j}}{m + 3m}$
 $= \frac{v}{4}\hat{i} + \frac{3v}{2}\hat{j}$

65. A converging beam of rays is incident on a diverging lens. Having passed through the lens the rays intersect at a point 15 cm from the lens on the opposite side. If the lens is removed the point where the rays meet will move 5 cm closer to the lens. The focal length of the lens is

- (1) -30 cm (2) 5 cm
(3) -10 cm (4) 20 cm

Ans. (1)

Sol. $v = +15$

$$u = +10$$

$$\frac{1}{v} - \frac{1}{u} = \frac{1}{f}$$

$$\therefore f = -30 \text{ cm}$$

66. The threshold frequency for a photosensitive metal is 3.3×10^{14} Hz. If light of frequency 8.2×10^{14} Hz is incident on this metal, the cut-off voltage for the photoelectric emission is nearly

- (1) 5 V (2) 1 V
(3) 2 V (4) 3 V

Ans. (3)

$$\text{Sol. } V = \frac{(8.2 - 3.3) \times 10^{14} \times 6.628 \times 10^{-34}}{1.6 \times 10^{-19}} = 2V$$

67. An electron in the hydrogen atom jumps from excited state n to the ground state. The wavelength so emitted illuminates a photosensitive material having work function 2.75 eV. If the stopping potential of the photoelectron is 10 V, then the value of n is

- (1) 5 (2) 2
(3) 3 (4) 4

Ans. (4)

$$\text{Sol. } -13.6 + 10 + 2.75 = -0.85 = \frac{-13.6}{n^2}$$

$$\therefore n = 4$$

68. The r.m.s. value of potential difference V shown in the figure is

- (1) $\frac{V_0}{2}$
(2) $\frac{V_0}{\sqrt{3}}$
(3) V_0
(4) $\frac{V_0}{\sqrt{2}}$

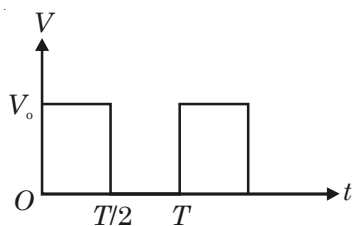

Ans. (4)

$$\text{Sol. } \sqrt{\frac{V_0^2 \cdot \frac{T}{2}}{T}} = \frac{V_0}{\sqrt{2}}$$

69. A particle of mass M is situated at the centre of a spherical shell of same mass and radius a . The magnitude of the gravitational potential at a point situated at $\frac{a}{2}$ distance from the centre, will be

- (1) $\frac{4GM}{a}$ (2) $\frac{GM}{a}$
(3) $\frac{2GM}{a}$ (4) $\frac{3GM}{a}$

Ans. (4)

$$\text{Sol. } \frac{GM}{a/2} + \frac{GM}{a} = \frac{3GM}{a}$$

70. Two particles are oscillating along two close parallel straight lines side by side, with the same frequency and amplitudes. They pass each other, moving in opposite directions when their displacement is half of the amplitude. The mean positions of the two particles lie on a straight line perpendicular to the paths of the two particles. The phase difference is

- (1) π (2) $\frac{\pi}{6}$
(3) 0 (4) $\frac{2\pi}{3}$

Ans. (4)

Sol. $X = A \sin \theta$

$$\frac{A}{2} = A \sin \theta$$

$$\therefore \theta = 30^\circ, 150^\circ$$

$$\therefore \text{Difference} = 150^\circ - 30^\circ = 120^\circ = \frac{2\pi}{3}$$

71. In the circuit shown in the figure, if the potential at point A is taken to be zero, the potential at point B is

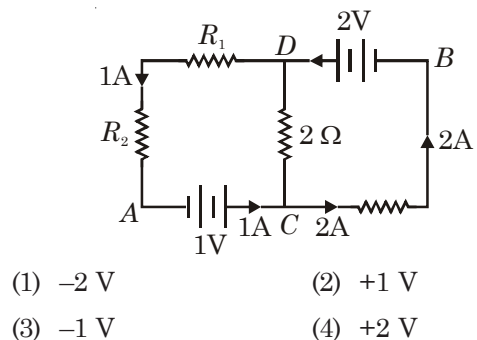

- (1) -2 V (2) +1 V
(3) -1 V (4) +2 V

Ans. (2)

Sol. $0 + 1 + 2 - 2 = V_B$

$\therefore V_B = 1 \text{ volt}$

72. A conveyor belt is moving at a constant speed of 2 m/s. A box is gently dropped on it. The coefficient of friction between them is $\mu = 0.5$. The distance that the box will move relative to belt before coming to rest on it, taking $g = 10 \text{ ms}^{-2}$, is

- (1) Zero (2) 0.4 m
(3) 1.2 m (4) 0.6 m

Ans. (2)

Sol. $u = 2 \text{ m/s}$

$a = -g\mu = -10 \times 0.5 = -5 \text{ m/s}^2$

$v^2 = u^2 + 2as \quad (v = 0)$

$\therefore s = \frac{2^2}{2 \times 5} = 0.4 \text{ m}$

73. A mass of diatomic gas ($\gamma = 1.4$) at a pressure of 2 atmospheres is compressed adiabatically so that its temperature rises from 27°C to 927°C . The pressure of the gas in the final state is

- (1) 256 atm (2) 8 atm
(3) 28 atm (4) 68.7 atm

Ans. (1)

Sol. $P = 2 \left(\frac{1200}{300} \right)^{\frac{7}{2}} = 256 \text{ atm}$

74. Charge q is uniformly spread on a thin ring of radius R . The ring rotates about its axis with a uniform frequency f Hz. The magnitude of magnetic induction at the center of the ring is :

- (1) $\frac{\mu_0 q}{2\pi f R}$ (2) $\frac{\mu_0 q f}{2\pi R}$
(3) $\frac{\mu_0 q f}{2R}$ (4) $\frac{\mu_0 q}{2f R}$

Ans. (3)

Sol. $B = \frac{\mu_0 I}{2R} = \frac{\mu_0 q f}{2R}$

75. A zener diode, having breakdown voltage equal to 15 V is used in a voltage regulator circuit shown in figure. The current through the diode is :

- (1) 20 mA
(2) 5 mA
(3) 10 mA
(4) 15 mA

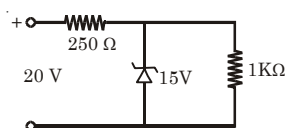

Ans. (2)

Sol. $\frac{20 - 15}{250} = \frac{15}{1000} = 5 \text{ mA}$

76. Out of the following which one is not a possible energy for a photon to be emitted by hydrogen atom according to Bohr's atomic model?

- (1) 13.6 eV (2) 0.65 eV
(3) 1.9 eV (4) 11.1 eV

Ans. (4)

Sol. Energy values are -13.6 eV , -3.4 eV , -1.51 eV , -0.85 eV etc. See the difference by hit and trial.

77. In the following figure, the diodes which are forward biased are

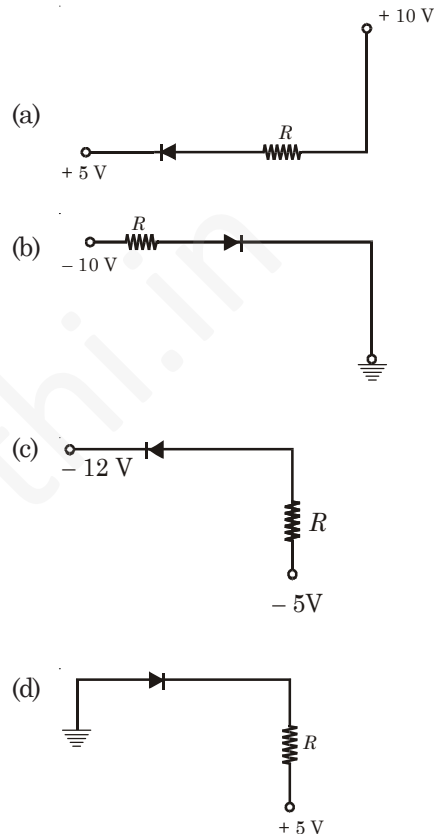

- (1) (b) and (d) (2) (a), (b) and (d)
(3) (c) only (4) (c) and (a)

Ans. (4)

Sol. P should be at higher voltage than N .

78. Two radioactive nuclei P and Q in a given sample decay into a stable nucleus R . At time $t = 0$, number of P species are $4N_0$ and that of Q are N_0 . Half-life of P (for conversion to R) is 1 minute whereas that of Q is 2 minutes. Initially there are no nuclei of R present in the sample. When number of nuclei of P and Q are equal the number of nuclei of R present in the sample would be :

- (1) $\frac{5N_0}{2}$ (2) $2N_0$
(3) $3N_0$ (4) $\frac{9N_0}{2}$

Ans. (4)

Sol. $4N_0e^{-2\lambda t} = N_0e^{-\lambda t}$

$4 = e^{\lambda t}$

$2 \ln 2 = \frac{\ln 2}{2} \cdot t \quad \therefore t = 4 \text{ min}$

$\therefore R = \left(4N_0 - \frac{N_0}{4}\right) + \left(N_0 - \frac{N_0}{4}\right) = \frac{9N_0}{2}$

79. Pure Si at 500 K has equal number of electron (n_e) and hole (n_h) concentrations of $1.5 \times 10^{16} \text{ m}^{-3}$. Doping by indium increases n_h to $4.5 \times 10^{22} \text{ m}^{-3}$. The doped semiconductor is of :

(1) n -type with electron concentration $n_e = 2.5 \times 10^{23} \text{ m}^{-3}$

(2) p -type having electron concentrations $n_e = 5 \times 10^9 \text{ m}^{-3}$

(3) n -type with electron concentration $n_e = 2.5 \times 10^{22} \text{ m}^{-3}$

(4) p -type with electron concentration $n_e = 2.5 \times 10^{10} \text{ m}^{-3}$

Ans. (2)

Sol. $\frac{(1.5 \times 10^{16})^2}{4.5 \times 10^{22}} = n_e = 5 \times 10^9 \text{ m}^{-3}$

80. A thin prism of angle 15° made of glass of refractive index $\mu_1 = 1.5$ is combined with another prism of glass of refractive index $\mu_2 = 1.75$. The combination of the prisms produces dispersion without deviation. The angle of the second prism should be

(1) 12°

(2) 5°

(3) 7°

(4) 10°

Ans. (4)

Sol. $(1.5 - 1) (15^\circ) = (1.75 - 1)A$

$\therefore A = 10^\circ$

81. Two identical piano wires, kept under the same tension T have a fundamental frequency of 600 Hz. The fractional increase in the tension of one of the wires which will lead to occurrence of 6 beats /s when both the wires oscillate together would be

(1) 0.04

(2) 0.01

(3) 0.02

(4) 0.03

Ans. (3)

Sol. $\frac{\Delta f}{f} = \frac{1}{2} \frac{\Delta T}{T} \therefore \frac{\Delta T}{T} = \frac{1}{50} = 0.02$

82. A small mass attached to a string rotates on a frictionless table top as shown. If the tension in the string is increased by pulling the string causing the radius of the circular motion to decrease by a factor of 2, the kinetic energy of the mass will

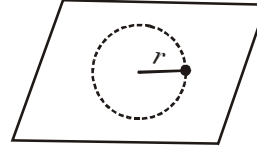

(1) Increase by a factor of 4

(2) Decrease by a factor of 2

(3) Remain constant

(4) Increase by a factor of 2

Ans. (1)

Sol. $mvr = \text{constant}$

$mvr = mv' \cdot \frac{r}{2} \therefore v' = 2v$

$\therefore KE' = \frac{1}{2} m(2v)^2 = 4 (KE)$

83. The electric potential V at any, point (x, y, z) , in meters in space is given by $V = 4x^2$ volt. The electric field at the point $(1, 0, 2)$ in volt/meter, is

(1) 16 along positive X-axis

(2) 8 along negative X-axis

(3) 8 along positive X-axis

(4) 16 along negative X-axis

Ans. (2)

Sol. $E = -\frac{\partial V}{\partial x} = -8x = -8 \text{ V/m}$

84. Three charges, each $+q$, are placed at the corners of an isosceles triangle ABC of sides BC and AC , $2a$. D and E are the mid points of BC and CA . The work done in taking a charge Q from D to E is

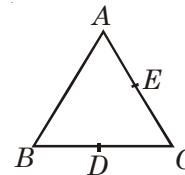

(1) Zero

(2) $\frac{3qQ}{4\pi\epsilon_0 a}$

(3) $\frac{3qQ}{8\pi\epsilon_0 a}$

(4) $\frac{qQ}{4\pi\epsilon_0 a}$

Ans. (1)

Sol. Both D and E are at same potential.

85. A particle of mass m is thrown upwards from the surface of the earth, with a velocity u . The mass and the radius of the earth are, respectively, M and R . G is gravitational constant and g is acceleration due to gravity on the surface of the earth. The minimum value of u so that the particle does not return back to earth, is

- (1) $\sqrt{2gR^2}$ (2) $\sqrt{\frac{2GM}{R^2}}$
 (3) $\sqrt{\frac{2GM}{R}}$ (4) $\sqrt{\frac{2gM}{R^2}}$

Ans. (3)

Sol. Escape velocity = u

86. A short bar magnet of magnetic moment 0.4 JT^{-1} is placed in a uniform magnetic field of 0.16 T . The magnet is in stable equilibrium when the potential energy is

- (1) -0.082 J (2) 0.064 J
 (3) -0.064 J (4) Zero

Ans. (3)

Sol. $-\mu B \cos\theta = -0.4 \times 0.16 \cdot \cos 0^\circ = -0.064 \text{ J}$

87. A square loop, carrying a steady current I , is placed in a horizontal plane near a long straight conductor carrying a steady current I_1 at a distance d from the conductor as shown in figure. The loop will experience

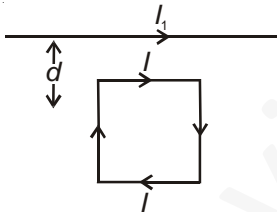

- (1) A net torque acting downward normal to the horizontal plane
 (2) A net attractive force towards the conductor
 (3) A net repulsive force away from the conductor
 (4) A net torque acting upward perpendicular to the horizontal plane

Ans. (2)

Sol. Adjacent wires carry current in the same direction so there will be attraction.

88. A projectile is fired at an angle of 45° with the horizontal. Elevation angle of the projectile at its highest point as seen from the point of projection is

- (1) $\tan^{-1}\left(\frac{\sqrt{3}}{2}\right)$ (2) 45°
 (3) 60° (4) $\tan^{-1}\frac{1}{2}$

Ans. (4)

Sol. $\tan\phi + \tan\phi = \tan\theta$

$$\therefore \tan\phi = \frac{\tan 45^\circ}{2}$$

89. A coil has resistances 30 ohm and inductive reactance 20 Ohm at 50 Hz frequency. If an ac source, of 200 volt , 100 Hz is connected across the coil, the current in the coil will be

- (1) $\frac{20}{\sqrt{13}} \text{ A}$ (2) 2.0 A
 (3) 4.0 A (4) 8.0 A

Ans. (3)

Sol. $Z = \sqrt{30^2 + (20 \times 2)^2} = 50 \Omega$

$$I = \frac{200}{50} = 4 \text{ A}$$

90. The density of a material in CGS system of units is 4 g/cm^3 . In a system of units in which unit of length is 10 cm and unit of mass is 100 g , the value of density of material will be

- (1) 400 (2) 0.04
 (3) 0.4 (4) 40

Ans. (4)

Sol. $\frac{4 \text{ g}}{\text{cm}^3} = \frac{x \cdot 100 \text{ g}}{(10 \text{ cm})^3}$
 $\therefore x = 40$

91. Match list-I with List-II for the composition of substances and select the correct answer using the code given below the lists

List-I Substances		List-II Composition	
(A)	Plaster of paris	(i)	$\text{CaSO}_4 \cdot 2\text{H}_2\text{O}$
(B)	Epsomite	(ii)	$\text{CaSO}_4 \cdot \frac{1}{2} \text{H}_2\text{O}$
(C)	Kieserite	(iii)	$\text{MgSO}_4 \cdot 7\text{H}_2\text{O}$
(D)	Gypsum	(iv)	$\text{MgSO}_4 \cdot \text{H}_2\text{O}$
		(v)	CaSO_4

Code :

- | | | | | |
|-----|------------|------------|------------|------------|
| | (A) | (B) | (C) | (D) |
| (1) | (i) | (ii) | (iii) | (iv) |
| (2) | (iv) | (iii) | (ii) | (i) |
| (3) | (iii) | (iv) | (i) | (ii) |
| (4) | (ii) | (iii) | (iv) | (i) |

Ans. (4)

Sol. Fact

92. Which of the following statements is incorrect?

- (1) Aluminium reacts with excess NaOH to give Al(OH)_3
- (2) NaHCO_3 on heating gives Na_2CO_3
- (3) Pure sodium metal dissolves in liquid ammonia to give blue solution
- (4) NaOH reacts with glass to give sodium silicate

Ans. (1)

Sol. Fact

93. Which of the statements about "Denaturation" given below are correct?

Statements :

- (a) Denaturation of proteins causes loss of secondary and tertiary structures of the protein
- (b) Denaturation leads to the conversion of double strand of DNA into single strand
- (c) Denaturation affects primary structure which gets distorted

Options

- (1) (a) and (b)
- (2) (a), (b) and (c)
- (3) (b) and (c)
- (4) (a) and (c)

Ans. (1)

Sol. Fact

94. The IUPAC name of the following compound is

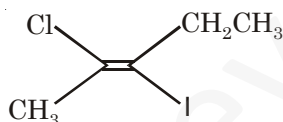

- (1) trans-3-iodo-4-chloro-3-pentene
- (2) cis-3-chloro-3-iodo-2-pentene
- (3) trans-2-chloro-3-iodo-2-pentene
- (4) cis-3-iodo-4-chloro-3-pentene

Ans. (3)

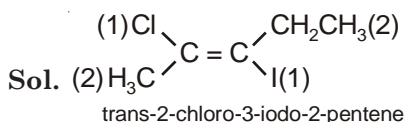

95. Which of the following oxide is amphoteric?

- (1) SiO_2
- (2) CO_2
- (3) SnO_2
- (4) CaO

Ans. (3)

Sol. Oxides of Sn is amphoteric.

96. Which of the following compounds undergoes nucleophilic substitution reaction most easily?

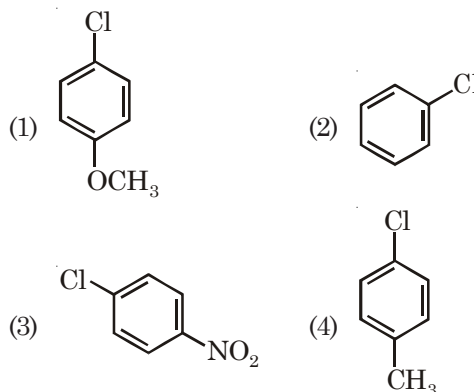

Ans. (3)

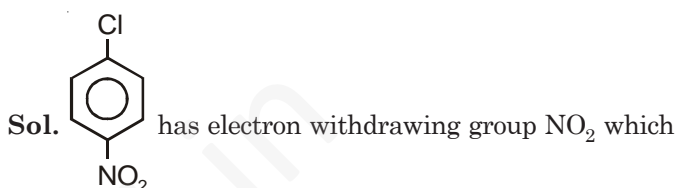

reduces the double bond character between carbon of benzene ring and chlorine.

97. A bubble of air is underwater at temperature 15°C and the pressure 1.5 bar. If the bubble rises to the surface where the temperature is 25°C and the pressure is 1.0 bar what will happen to the volume of the bubble?

- (1) Volume will become smaller by a factor of 0.70
- (2) Volume will become greater by a factor of 2.5
- (3) Volume will become greater by a factor of 1.6
- (4) Volume will become greater by a factor of 1.1

Ans. (3)

Sol. $\therefore \frac{P_1 V_1}{T_1} = \frac{P_2 V_2}{T_2}$
 $\Rightarrow \frac{1.5 \times V_1}{288} = \frac{1 \times V_2}{298}$
 $\therefore V_2 = \frac{1.5 \times 298 \times V_1}{288}$
 $= 1.55 V_1$
 $\approx 1.6 V_1$

98. An organic compound 'A' on treatment with NH_3 gives 'B' which on heating gives 'C' when treated presence of KOH produces ethylamine. Compound with Br in the 'A' is

- (1) $\text{CH}_3 - \text{CH}(\text{COOH}) - \text{CH}_3$
- (2) $\text{CH}_3\text{CH}_2\text{COOH}$
- (3) CH_3COOH
- (4) $\text{CH}_3\text{CH}_2\text{CH}_2\text{COOH}$

Ans. (2)

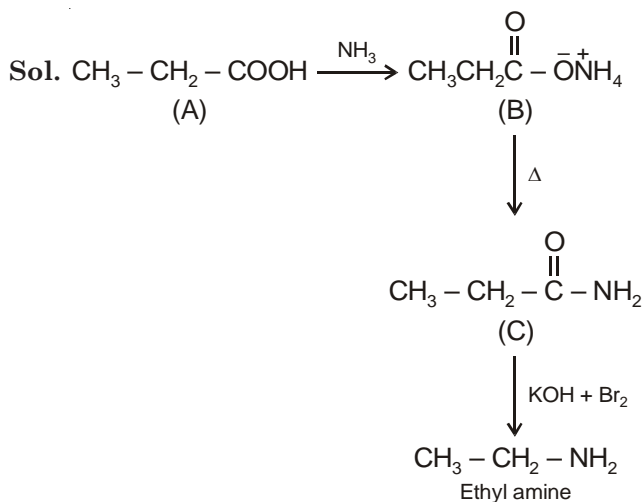

99. Consider the following process

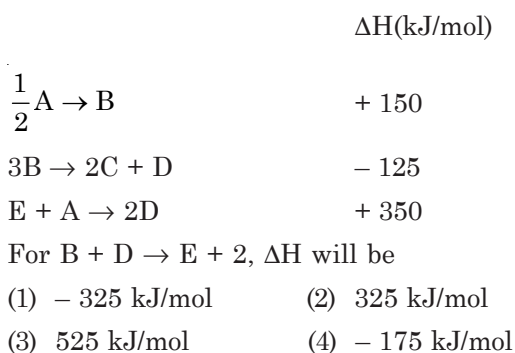

Ans. (4)

Sol. We have,

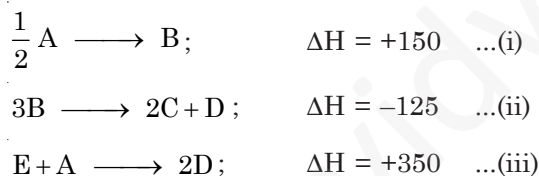

By $[2 \times (\text{i}) + (\text{ii})] - (\text{iii})$, we have

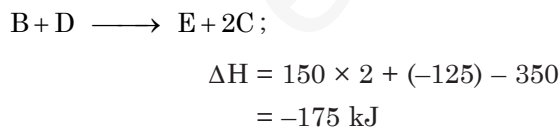

100. A 0.1 molal aqueous solution of a weak acid is 30% ionized. If K_f for water is $1.86^\circ\text{C}/\text{m}$, the freezing point of the solution will be

- (1) -0.36°C (2) -0.24°C
(3) -0.18°C (4) -0.54°C

Ans. (2)

Sol. For 30% dissociation,

$$i = 1.3$$

$$\therefore \Delta T_f = 1.3 \times 1.86 \times 0.1$$

$$= 0.2418$$

\therefore Freezing point of solution is -0.24°C .

101. The following reactions take place in the blast furnace in the preparation of impure iron. Identify the reaction pertaining to the formation of the slag.

- (1) $\text{CaO}(\text{s}) + \text{SiO}_2(\text{s}) \rightarrow \text{CaSiO}_3(\text{s})$
(2) $2\text{C}(\text{s}) + \text{O}_2(\text{g}) \rightarrow 2\text{CO}(\text{g})$
(3) $\text{Fe}_2\text{O}_3(\text{s}) + 3\text{CO}(\text{g}) \rightarrow 2\text{Fe}(\text{l}) + 3\text{CO}_2(\text{g})$
(4) $\text{CaCO}_3(\text{s}) \rightarrow \text{CaO}(\text{s}) + \text{CO}_2(\text{g})$

Ans. (1)

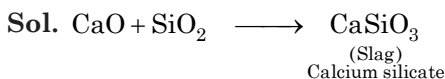

102. In qualitative analysis, the metals of group I can be separated from other ions by precipitating them as chloride salts. A solution initially contains Ag^+ and Pb^{2+} at a concentration is 0.10 M. Aqueous HCl is added to this solution until the Cl^- concentration is 0.10 M. What will the concentration of Ag^+ and Pb^{2+} be at equilibrium?

(K_{sp} for $\text{AgCl} = 1.8 \times 10^{-10}$, K_{sp} for $\text{PbCl}_2 = 1.7 \times 10^{-5}$)

- (1) $[\text{Ag}^+] = 1.8 \times 10^{-9} \text{ M}$
 $[\text{Pb}^{2+}] = 1.7 \times 10^{-3} \text{ M}$
(2) $[\text{Ag}^+] = 1.8 \times 10^{-11} \text{ M}$
 $[\text{Pb}^{2+}] = 1.7 \times 10^{-4} \text{ M}$
(3) $[\text{Ag}^+] = 1.8 \times 10^{-7} \text{ M}$
 $[\text{Pb}^{2+}] = 1.7 \times 10^{-6} \text{ M}$
(4) $[\text{Ag}^+] = 1.8 \times 10^{-11} \text{ M}$
 $[\text{Pb}^{2+}] = 8.5 \times 10^{-5} \text{ M}$

Ans. (1)

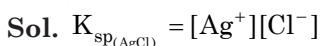

$$\therefore [\text{Ag}^+] = \frac{1.8 \times 10^{-10}}{10^{-1}}$$

$$= 1.8 \times 10^{-9} \text{ M}$$

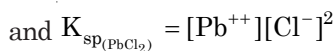

$$\therefore [\text{Pb}^{2+}] = \frac{1.7 \times 10^{-5}}{10^{-1} \times 10^{-1}}$$

$$= 1.7 \times 10^{-3} \text{ M}$$

103. Which of the following structures is the most preferred and hence of lowest energy for SO_3 ?

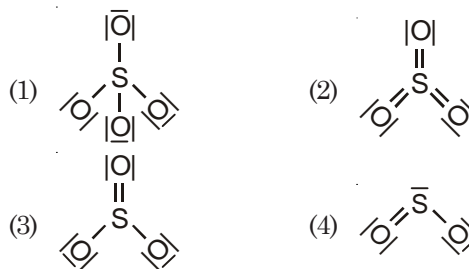

Ans. (2)

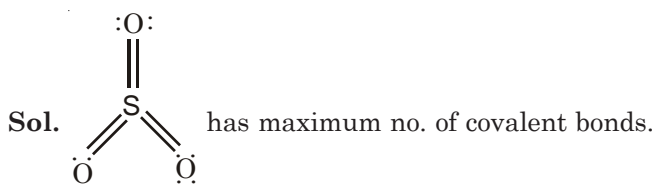

104. The unit of rate constant for a zero order reaction is

- (1) $L^2 \text{ mol}^{-2} \text{ s}^{-1}$ (2) s^{-1}
(3) $\text{mol L}^{-1} \text{ s}^{-1}$ (4) $\text{L mol}^{-1} \text{ s}^{-1}$

Ans. (3)

Sol. For zero order reaction,

$$\text{Rate} = K \cdot [\text{Reactant}]^0$$

$$\therefore \text{Rate} = K$$

$$\therefore \text{Unit of } K \text{ is } \text{mol L}^{-1} \text{ s}^{-1}$$

105. A solution contains Fe^{2+} , Fe^{3+} and I^- ions. This solution was treated with iodine at 35°C . E° for $\text{Fe}^{3+}/\text{Fe}^{2+}$ is $+0.77 \text{ V}$ and E° for $\text{I}_2/2\text{I}^- = 0.536 \text{ V}$. The favourable redox reaction is

- (1) I^- will be oxidised to I_2
(2) Fe^{2+} will be oxidised to Fe^{3+}
(3) I_2 will be reduced to I^-
(4) There will be no redox reaction

Ans. (1)

Sol. For $\text{I}^- \rightarrow \text{I}_2$; the value of E° is +ve.

So, it is favourable redox reaction.

106. 200 mL of an aqueous solution of a protein contains its 1.26 g. The Osmotic pressure of this solution at 300 K is found to be $2.57 \times 10^{-3} \text{ bar}$. The molar mass of protein will be ($R = 0.083 \text{ L bar mol}^{-1} \text{ K}^{-1}$)

- (1) 31011 g mol^{-1} (2) 61038 g mol^{-1}
(3) 51022 g mol^{-1} (4) $122044 \text{ g mol}^{-1}$

Ans. (2)

$$\text{Sol. } \therefore \pi = \frac{w \times 1000}{M \times V} \times R \times T$$

$$\therefore M = \frac{w \times 1000}{\pi \times V} \times R \times T$$

$$= \frac{1.26 \times 1000 \times 0.083 \times 300}{2.57 \times 10^{-3} \times 200}$$

$$= 61038 \text{ g mol}^{-1}$$

107. The rate of the reaction

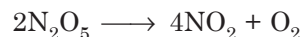

can be written in three ways :

$$\frac{-d[\text{N}_2\text{O}_5]}{dt} = k[\text{N}_2\text{O}_5]$$

$$\frac{d[\text{NO}_2]}{dt} = k'[\text{N}_2\text{O}_5]$$

$$\frac{d[\text{O}_2]}{dt} = k''[\text{N}_2\text{O}_5]$$

The relationship between k and k' and between k and k'' are

- (1) $k' = 2k$; $k'' = 2k$ (2) $k' = k$; $k'' = k$
(3) $k' = 2k$; $k'' = k$ (4) $k' = 2k$; $k'' = k/2$

Ans. (4)

$$\text{Sol. Rate} = -\frac{1}{2} \frac{d[\text{N}_2\text{O}_5]}{dt} = \frac{1}{4} \frac{d[\text{NO}_2]}{dt} = \frac{d[\text{O}_2]}{dt}$$

$$\therefore 2k = k' = 4k''$$

108. The half life of a substance in a certain enzyme-catalysed reaction is 138 s. The time required for the concentration of the substance to fall from 1.28 mg L^{-1} to 0.04 mg L^{-1} is

- (1) 690 s (2) 276 s
(3) 414 s (4) 552 s

Ans. (1)

Sol. \therefore Fall from 1.28 mg L^{-1} to 0.04 mg L^{-1} involves five half-lives.

$$\begin{aligned} \therefore \text{Time-required} &= 5 \times t_{1/2} \\ &= 5 \times 138 \text{ s} \\ &= 690 \text{ s} \end{aligned}$$

109. Which of the following complex compounds will exhibit highest paramagnetic behaviour?

- (1) $[\text{Co}(\text{NH}_3)_6]^{3+}$ (2) $[\text{Zn}(\text{NH}_3)_6]^{2+}$
(3) $[\text{Ti}(\text{NH}_3)_6]^{3+}$ (4) $[\text{Cr}(\text{NH}_3)_6]^{3+}$

(At. No. Ti = 22, Cr = 24, Co = 27, Zn = 30)

Ans. (4)

$[\text{Cr}(\text{NH}_3)_6]^{3+}$ has 3 unpaired e^-

110. A solid compound XY has NaCl structure. If the radius of the cation is 100 pm, the radius of the anion (Y^-) will be

- (1) 241.5 pm (2) 165.7 pm
(3) 275.1 pm (4) 322.5 pm

Ans. (1)

Sol. For NaCl structure,

$$\frac{X^+}{Y^-} = 0.414$$

$$\therefore Y^- = \frac{100}{0.414} = 241.5 \text{ pm}$$



111. Which of the following is **not** a fat soluble vitamin?

- (1) Vitamin E (2) Vitamin A
(3) Vitamin B complex (4) Vitamin D

Ans. (3)

Sol. Fact

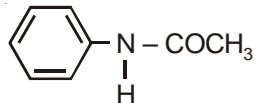
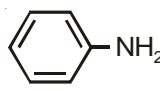
112. Which of the following compounds is most basic?

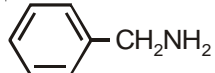
- (1) 
- (2) 
- (3) 
- (4) 

Ans. (4)

Sol. Lone pair of N does not involve in resonance with benzene ring.

113. Which has the maximum number of molecules among the following?

- (1) 8 g H₂ (2) 64 g SO₂
(3) 44 g CO₂ (4) 48 g O₃

Ans. (1)

Sol. 64 g SO₂ ⇒ 1 mole SO₂ ⇒ N_A molecules

44 g CO₂ ⇒ 1 mole CO₂ ⇒ N_A molecules

48 g O₃ ⇒ 1 mole O₃ ⇒ N_A molecules

8 g H₂ ⇒ 4 mole H₂ ⇒ 4 × N_A molecules

114. Match the compounds given in List-I with List-II and select the suitable option using the code given below.

- | List-I | List-II |
|-----------------------|---------------------------|
| a. Benzaldehyde | (i) Phenolphthalein |
| b. Phthalic anhydride | (ii) Benzoin condensation |
| c. Phenyl benzoate | (iii) Oil of wintergreen |
| d. Methyl salicylate | (iv) Fries rearrangement |

(1) a(ii), b(iii), c(iv), d(i)

(2) a(ii), b(i), c(iv), d(iii)

(3) a(iv), b(i), c(iii), d(ii)

(4) a(iv), b(ii), c(iii), d(i)

Ans. (2)

Sol. Fact

115. What is the value of electron gain enthalpy of Na⁺ if IE₁ of Na = 5.1 eV?

- (1) +2.55 eV (2) +10.2 eV
(3) -5.1 eV (4) -10.2 eV

Ans. (3)

Sol. Electron gain enthalpy is reverse of ionisation energy.

116. Which of the following carbonyls will have the strongest C – O bond?

- (1) V(CO)₆⁻ (2) Fe(CO)₅
(3) Mn(CO)₆⁺ (4) Cr(CO)₆

Ans. (1)

Sol. V⁻ has lesser tendency to accept electron pair.

117. The order of reactivity of phenyl magnesium bromide (PhMgBr) with the following compounds :

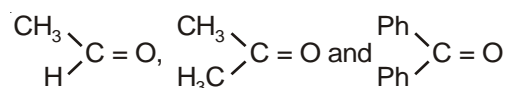

- (1) I > III > II (2) I > II > III
(3) III > II > I (4) II > I > III

Ans. (2)

Sol. Electron density increases from I to III on carbonyl carbon.

118. The pairs of species of oxygen and their magnetic behaviours are noted below. Which of the following presents the correct description?

- (1) O₂⁺, O₂ – Both paramagnetic
(2) O, O₂²⁻ – Both paramagnetic
(3) O₂⁻, O₂²⁻ – Both diamagnetic
(4) O⁺, O₂²⁻ – Both paramagnetic

Ans. (1)

Sol. The molecular orbital configurations of O_2^+ , O_2^- , O_2^{--} and O_2 are

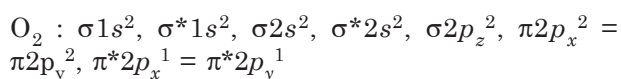
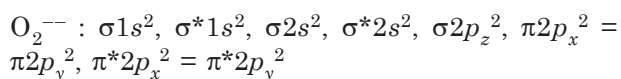
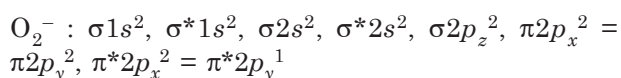
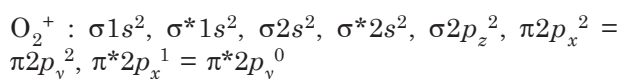

And the electronic configurations of O and O^+ are

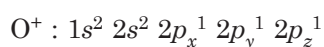
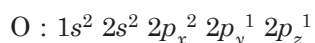

119. According to the Bohr Theory, which of the following transitions in the hydrogen atom will give rise to the **least energetic** photon?

(1) $n = 6$ to $n = 5$ (2) $n = 5$ to $n = 3$

(3) $n = 6$ to $n = 1$ (4) $n = 5$ to $n = 4$

Ans. (1)

Sol. $\Delta E \propto \left[\frac{1}{n_1^2} - \frac{1}{n_2^2} \right]$, where $n_2 > n_1$

$\therefore n = 6$ to $n = 5$ will give least energetic photon.

120. Consider the reactions :

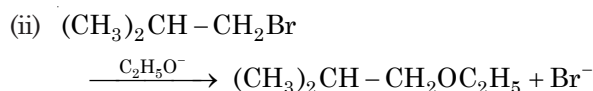
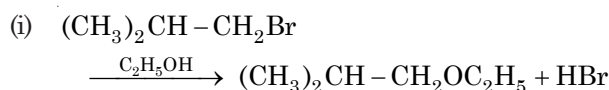

The mechanisms of reactions (i) and (ii) are respectively

(1) S_N2 and S_N2 (2) S_N2 and S_N1

(3) S_N1 and S_N2 (4) S_N1 and S_N1

Ans. (1)

Sol. The product formed according to S_N2 mechanism in both the reactions.