

Class XII Physics

CBSE Board Set – 3

General Instructions:

1. There are 26 questions in all. All questions are compulsory,
2. This question paper has five sections: Section A, Section B, Section C, Section D and Section E.
3. Section A contains five question of one mark each. Section B contains five questions of two marks each. Section C contains twelve questions of three marks each. Section D contains one value based question of four marks and Section E contains three questions of five marks each.
4. There is no overall choice. However, on internal choice has been provided in one question of two marks, one question of three marks and all the three questions of five marks weightage. You have to attempt only one of the choices in such questions.
5. You may use the following values of physical constants wherever necessary:

$$c = 3 \times 10^8 \text{m/s}$$

$$h = 6.63 \times 10^{-34} \text{Js}$$

e

TmA

N⁻¹m

—

N m

Mass of neutron

Mass of proton =

Avogadro's number = per gram mole

Boltzmann constant JK

Section – A

Q1. A concave lens of refractive index 1.5 is immersed in a medium of refractive index 1.65. What is the nature of the lens?

Sol.1 When refractive index of the medium is greater than the refractive index of the lens the nature of the lens will change i.e. convex will change into concave and concave will behave as convex.

Q2. How is side bands produced?

Sol.2 In radio communications, a sideband is a band of frequencies higher or lower than the carrier frequency, containing power as a result of the modulation process. The sidebands consist of all the Fourier components of the modulated signal except the carrier. All forms of modulation produce sidebands.

Q3. Graph showing the variation of current versus voltage for a material GaAs is shown in the figure. Identify the region of

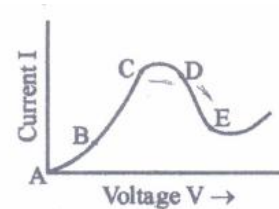

- (i) Negative resistance
- (ii) Where Ohm's law is obeyed.

Sol.3 (a) Resistance is dV/dI . So resistance is negative when slope is negative. That is region DE
(b) in region BC Ohm's law is obeyed because graph is linear. $V=IR$ is getting satisfied.

Q4. Define capacitor reactance. Write its S.I. units.

Sol.4 Capacitive reactance is an opposition to the change of voltage across an element. Capacitive reactance X_c is inversely proportional to the signal frequency f (or angular frequency ω) and the capacitance C .

Capacitive Reactance has the electrical symbol " X_c " and has units measured in Ohms the same as resistance, (R) .

Q5. What is the electric flux through a cube of side 1 cm which encloses an electric dipole?

Sol.5 Net Electric Flux through a closed surface containing an electric dipole is **ZERO**

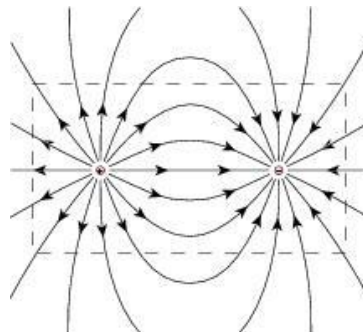

Section – B

Q6. Distinguish between ‘intrinsic’ and ‘extrinsic’ semiconductors.

Sol.6 Intrinsic semiconductors:

1. Intrinsic semiconductors are the crystals of pure elements like germanium and silicon.
2. In intrinsic semiconductor, the number density of electrons is equal to the number density of holes. i.e., $n_e = n_h$.
3. The electrical conductivity of intrinsic semiconductors is low.
4. The electrical conductivity of intrinsic semiconductors mainly depends on their temperatures.

Extrinsic semiconductors:

1. When some impurity is added in the intrinsic semiconductor, we get an extrinsic semiconductor.
2. In extrinsic semiconductor, the number density of electrons is not equal the number density of holes. i.e., n_e is not equal to n_h .
3. The electrical conductivity of extrinsic semiconductors is high.
4. The electrical conductivity of extrinsic semiconductors depends on the temperature as well as the amount of impurity added in them.

Q7. Use the mirror equation to show that an object placed between f and $2f$ of a concave mirror produces a real image beyond $2f$.

Sol.7 (a) For a concave mirror, the focal length (f) is negative

$$\therefore f < 0$$

When the object is placed on the left side of the mirror, the object distance (u) is negative

$$\therefore u < 0$$

For image distance v , we can write the lens formula as:

$$\frac{1}{v} - \frac{1}{u} = \frac{1}{f}$$

$$\frac{1}{v} = \frac{1}{f} + \frac{1}{u} \quad \dots (1)$$

The object lies between f and $2f$

$$\therefore 2f < u < f \quad (\because u \text{ and } f \text{ are negative})$$

$$\frac{1}{v} < \frac{1}{f} + \frac{1}{f}$$

$$\frac{1}{v} < \frac{2}{f} \quad \therefore v < \frac{f}{2}$$

$$- \dots - < - \dots - < \dots (2)$$

Using equation (1), we get

$$- \dots - < - \dots - <$$

\therefore $-$ is negative, i. e. v is negative

$$- \dots - < - \dots - <$$

Therefore the image lies-beyond $2f$

OR

Q7. Find an expression for intensity of terminated light when a polaroid sheet is rotated between two crossed polaroid's. In which position of the polaroid sheet will the terminated intensity be maximum?

Sol.7

MALUS' LAW

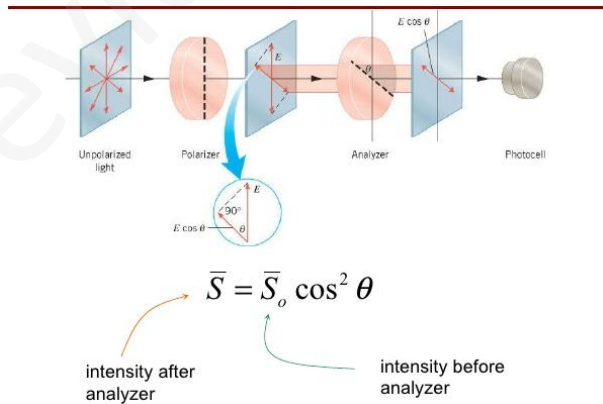

At $\theta = 0^\circ$, the intensity will be maximum.

Q8. Use Kirchhoff's rules to obtain conditions for the balance condition in a Wheatstone bridge.

Sol.8 (i) Wheat stone bridge is an electric circuit used to compare resistances or to find the value of unknown resistance.

(ii) It consists of four resistances P, Q, R and S that are connected to form four sides of a quadrilateral.

(iii) These four sides are referred as arms of the bridge. Four junctions are formed at A, B, C and D.

(iv) A battery of emf 'e' is connected between two junctions A and B. A galvanometer of resistance G ohms is connected between C and D.

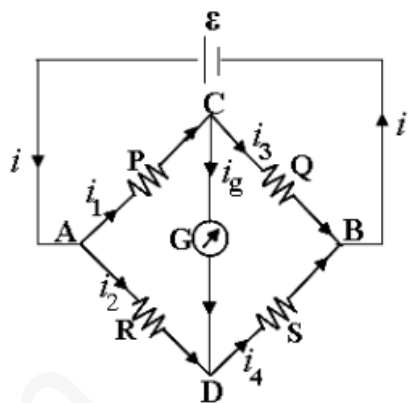

Applying Kirchoff's first law.

at junction C, $i_1 = i_e = i_3$ (1)

at junction D, $i_2 + i_e = i_4$ (2)

Applying Kirchoff's second law, for the loop ACDA

$-i_1 P - i_g G + i_2 R = 0$ (3)

Applying Kirchoff's second law, for the loop CBDC

$-i_3 Q + i_4 S + i_g G = 0$ (4)

The values of P, Q, R and S are suitably adjusted so that, no current should pass through galvanometer. Then Wheatstone bridge is said to be balanced. Substituting $i_g = 0$ in equations (1), (2), (3) and (4) we get

$i_1 = i_3$ (5) and $i_2 = i_4$ (6)

$i_1 P = i_2 R$ (7) and $i_3 Q = i_4 S$ (8)

Using equations (5) & (6) dividing equation (7) by (8), we get – –

When no current passes through galvanometer, then – – This is balancing condition for

Wheatstone bridge and is called as Wheatstone bridge principle.

The balancing condition does not change on interchanging battery and galvanometer, in Wheatstone circuit.

Q9. A proton and an α -particle have the same de-Broglie wavelength. Determine the ratio of (i) their accelerating potentials (ii) their speed.

Sol.9 Charge of α particle = $2e$; charge of proton = e

Mass of α particle = 4 mass of proton

Debroglie wave length $\Rightarrow \lambda = \frac{h}{\sqrt{2m}}$

(a) ratio of accelerating potential given

$$\frac{\sqrt{2m_1}}{\sqrt{2m_2}} = \frac{\sqrt{2 \times 4m}}{\sqrt{2m}} = 2 = 8$$

(b) $\lambda = \frac{h}{mv}$

Q10. Show that the radius of the orbit in hydrogen atom varies as n^2 , where n is the principal quantum number of the atom.

Sol.10 Radius and Energy Levels of Hydrogen Atom:

Consider an electron of mass 'm' and charge 'e' revolving around a nucleus of charge Ze (where, Z = atomic number and e is the charge of the proton) with a tangential velocity v. r is the radius of the orbit in which electron is revolving.

By Coulomb's Law, the electrostatic force of attraction between the moving electron and nucleus is

Coulombic force = $\frac{Ze^2}{4\pi\epsilon_0 r^2}$

$K = \frac{1}{4\pi\epsilon_0}$ (where ϵ_0 is permittivity of free space)

$K = 9 \times 10^9 \text{ Nm}^2 \text{ C}^{-2}$

In C.G.S. units, value of $K = 1 \text{ dyne cm}^2 \text{ (esu)}^{-2}$

The centrifugal force acting on the electron is $\frac{mv^2}{r}$

Since the electrostatic force balances the centrifugal force, for the stable electron orbit.

$$\frac{Ze^2}{4\pi\epsilon_0 r^2} = \frac{mv^2}{r} \quad \dots (1)$$

$$\text{(or) } v^2 = \frac{Ze^2}{4\pi\epsilon_0 m r} \quad \dots (2)$$

According to Bohr's postulate of angular momentum quantization, we have

$$mvr = \frac{nh}{2\pi}$$

$$v = \frac{nh}{2\pi mr}$$

$$v^2 = \frac{n^2 h^2}{4\pi^2 m^2 r^2} \dots (3)$$

Equating (2) and (3)

$$\frac{nh}{2\pi mr} = \frac{n^2 h^2}{4\pi^2 m^2 r^2}$$

Solving for r we get $r = \frac{nh}{4\pi^2 m^2 v}$

Section - C

Q11. State the principle of working of a galvanometer.

A galvanometer of resistance G is converted into a voltmeter to measure upto V volts by connecting a resistance R_1 in series with the coil. If a resistance R_2 is connected in series with it, then it can measure upto $V/2$ volts. Find the resistance, in terms of R_1 and R_2 required to be connected to convert it into a voltmeter that can read upto $2V$. Also find the resistance G of the galvanometer in terms of R_2 and R_3 .

Sol.11 A Moving Coil Galvanometer works on the **Electromagnetic effect** of current carrying coil (free to move) being placed in an air-gap between the soft iron core and the strong pole pieces of the magnet.

The current flowing in the moving coil which is the specimen to be sensed or measured results in a generation of a Magnetic Field which is opposite to that of the fixed magnetic pole pieces. And as like poles attract each other results in a generation of small deflecting torque which further deflects the pointer or the mirror attached to the axis of the coil.

$$\text{So, } Ig (G + R_1) = v \quad \dots (i)$$

$$Ig (G + R_2) = v/2 \quad \dots (ii)$$

$$\text{So, } \frac{v}{2} = \frac{v(G + R_1)}{2(G + R_2)}$$

$$\Rightarrow G + 2R_2 = G + R_1$$

$$\Rightarrow G = R_1 - 2R_2 \quad \dots (a)$$

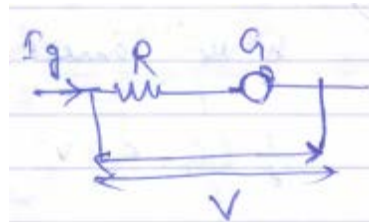

Let, Resistance to be connected be 'R'

$$\text{So, } I_g (G + R) = 2v$$

$$\Rightarrow \text{---} = 2 \quad \text{why (i)}$$

$$\text{So, } G + R = 2G + 2R_1$$

$$\Rightarrow G = R - 2R_1 \quad \dots (b)$$

Using (a) & (b)

$$R_1 - 2R_2 = R - 2R_1$$

$$\Rightarrow R_1 - 2R_2 = R$$

$$\Rightarrow R = 3R_1 - 2R_2$$

$$\text{And } G = R_1 - 2R_2 \quad \text{From (a).}$$

Q12. With what considerations in view, a photodiode is fabricated? State its working with the help of suitable diagram.

Even though the current in the forward bias is known to be more than in the reverse bias, yet the photodiode works in reverse bias. What is the reason?

Sol.12 The diode is fabricated such that the generation of e-h pairs takes place in or near the depletion region of the diode. Due to electric field of the junction. Electrons and holes are separated before they recombine. The direction of the electric field is such that electrons reach n-side and holes reach p-side. Electrons are collected on n-side and holes are collected on p-side is connected, current flows, the magnitude of the photocurrent depends on the intensity of incident light (photocurrent is proportional to incident light intensity).

Consider the case of an n-type semiconductor. Obviously, the majority carrier density (n) is considerably larger than the minority hole density p (i.e., $n \gg p$). On illumination, let the excess electrons and holes generated be Δn and Δp , respectively:

$$n' = n + \Delta n$$

$$p' = p + \Delta p$$

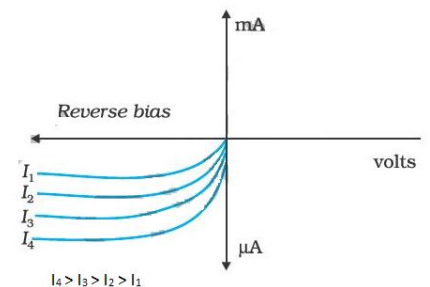
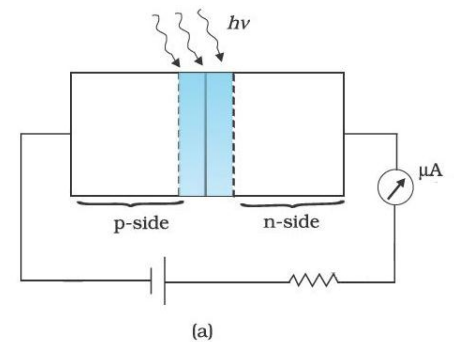

Here n' and p' are the electron and hole concentrations at any particular illumination and n and p are carrier's concentration when there is no illumination. Remember $\Delta n = \Delta p$ and $n \gg p$.

Q13. Draw a circuit diagram of a transistor amplifier in CE configuration.

Define the terms: (i) input resistance and (ii) Current amplification factor. How are these determined using typical input and output characteristics?

Sol.13

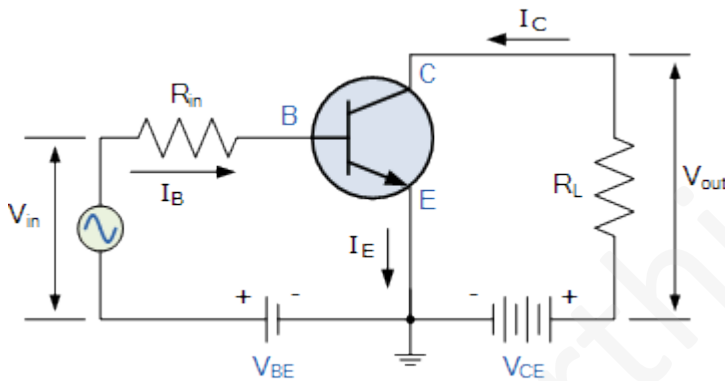

The input resistance is defined as the ratio of the input voltage to the input current. The input voltage is V_{in} and the input current is simply the differential input current I_d .

Current Amplification Factor or Current Gain is basically the ratio of the output current to the input current when its passing through an electrical device. So, it gives us the amount of current gained as it flows through.

Change in Output current/change in input current
For example: for CE Transistor, $\beta = \Delta i_c / \Delta i_b$

Q14. (a) In a double slit experiment using light of wavelength 600 nm, the angular width of the fringe formed on a distant screen is 0.1° . Find the spacing between the two slits.

(b) Light of wavelength 5000 \AA propagating in air gets partly reflected from the surface of water. How will the wavelengths and frequencies of the reflected and refracted light be affected?

Sol.14 (a) We know that,

fringe width = β —

Since, $\tan \theta$

then, $\tan \theta$ —

$$\Rightarrow \dots \Rightarrow \theta \quad /d$$

$$\Rightarrow \dots \frac{\dots}{\dots}$$

$$= \dots$$

$$34.4 \times 10^{-5} \text{ m}$$

$$= 3.44 \times 10^{-4} \text{ m} = 0.344 \text{ mm}$$

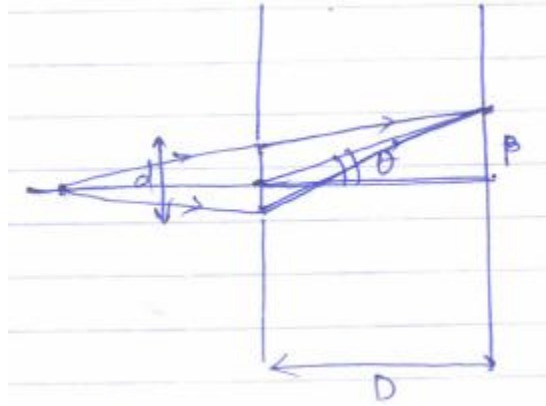

(b) Frequency of the reflected and refracted lights remains the same. As the velocity of light decreases in water which implies wavelength decreases in water. Thus, the refracted light has lower wavelength than reflected light.

Q15. An inductor L of inductance X_L is connected in series with a bulb B and an ac source. How would brightness of the bulb change when (i) number of turn in the inductor is reduced, (ii) an iron rod is inserted in the inductor and (iii) a capacitor of reactance $X_C = X_L$ is inserted in series in the circuit. Justify your answer in each case.

Sol.15 In the Circuit, $V_L + V_R = V$

$$\text{So,} \quad V_R = V - V_L$$

(i) When the number of turns is reduced, its Inductance (L) reduces hence V_L . So, V_R increases thereby the brightness increases.

(ii) When an iron rod is inserted, L increases, which implies V_L increases means V_R decreases. Thus brightness decreases.

(iii) When a capacitor of reactance is inserted such that $X_C = X_L$; Resonance condition is achieved; which means that the whole voltage supply effectively drops across the resistance only. Thus, the brightness is greatest as V_R is highest in this case.

Q16. Name the part of the electromagnetic spectrum which is

(a) suitable for radar systems used in aircraft navigation.

(b) used to treat muscular strain

(c) used as a diagnostic tool in medicine

Write in beset, below them wares can be produced.

Sol.16 a. Microwave

b. infrared

c. X-ray

Microwaves have frequencies ranging from 3×10^9 to 3×10^{11} Hz (3 GHz to 300 GHz) and wavelengths from 10^{-3} m to 10^{-1} (1 mm to 100 mm). Microwaves are produced by vacuum tubes devices that operate on the ballistic motion of electron controlled by magnetic or electric fields.

Infrared (IR) light is light with lower frequency (higher wavelength) than visible light. IR light has frequencies ranging from 3×10^{11} to 4×10^{14} Hz (300 GHz to 400 THz) and wavelengths from 7.5×10^{-7} m to 10^{-3} m (750 nm to 1 mm). Infrared light is emitted from all objects at or near room temperature in the form of blackbody radiation.

X-rays have frequencies ranging from 3×10^{16} to 3×10^{19} Hz (30 PHz to 30 EHz) and wavelengths from 10^{-11} m to 10^{-8} m (10 pm to 10 nm). Medical X-rays are produced by colliding high-energy electrons into a metal target, usually tungsten.

- Q17.** (i) A giant refracting telescope has an objective lens of focal length 15 m. If an eye piece of focal length 1.0 cm is used, what is the angular magnification of the telescope?
- (ii) If this telescope is used to view the moon. What is the diameter of the image of the moon formed by the objective lens? The diameter of the moon is 3.48×10^6 m and the radius of lunar orbit is 3.8×10^8 m.

Sol.17 (i) A focal length of the objective lens $f_0 = 15\text{m} = 15 \times 10^2\text{cm}$

Focal length of the eyepiece $f_e = 1.0$ cm

(a) An angular magnification of a telescope is given as

$$A = f_0/f_e$$

$$= 15 \times 10^2 / 1.0 = 1500$$

Therefore, the angular magnification of the given refracting telescope is 1500

(ii) A diameter of the moon $d = 3.48 \times 10^6\text{m}$

The Radius of the lunar orbit $r_0 = 3.8 \times 10^8\text{m}$

Let d' be the diameter of the image of the moon formed by the objective lens.

An angle subtended by the diameter of the moon is equal to the angle subtended by the image.

— —

$$\text{—————} \quad \text{—}$$

$$\therefore \text{—————}$$

$$= 13.74 \times 10^{-2} \text{ m} = 13.74 \text{ cm}$$

Therefore the diameter of the moon's image formed by the objective lens is 13.74cm.

Q18. Write Einstein's photoelectric equation and mention which important features in photoelectric effect can be explained with the help of this equation.

The maximum kinetic energy of the photoelectrons gets doubled when the wavelength of light incident on the surface changes from λ_1 to λ_2 . Derive the expressions for the threshold wavelength λ_1 and work function for the metal surface.

Sol.18 $h\nu = h\nu_0 + \frac{1}{2}mv^2 \dots\dots\dots (i)$

Where h = plank's constant

V = velocity of emitted electron

ν = frequency of incident light

ν_0 = threshold frequency

m = mass of emitted electron

$$h(\nu - \nu_0) = \frac{1}{2}mv^2 \dots\dots\dots (1)$$

$$2 \times \text{kmax} = h(\nu - \nu_0) \dots\dots\dots (2)$$

$$2 \times \left(\frac{1}{2}mv^2 \right) = h(\nu - \nu_0)$$

$$mv^2 = h(\nu - \nu_0)$$

$$\Rightarrow \text{—————} \quad \text{—}$$

Thresh hold wavelength = $\frac{c}{\nu_0}$

$$\text{Work function} = h\nu_0 = \frac{hc}{\lambda_0}$$

Q19. In the study of Geiger-Marsdon experiment on scattering of α particles by a thin foil of gold, draw the trajectory of α -particles in the coulomb field of target nucleus. Explain briefly how one gets the information on the size of the nucleus from this study.

From the relation $R = R_0 A^{1/3}$, where R_0 is constant and A is the mass number of the nucleus, show that nuclear matter density is independent of A .

Sol.19

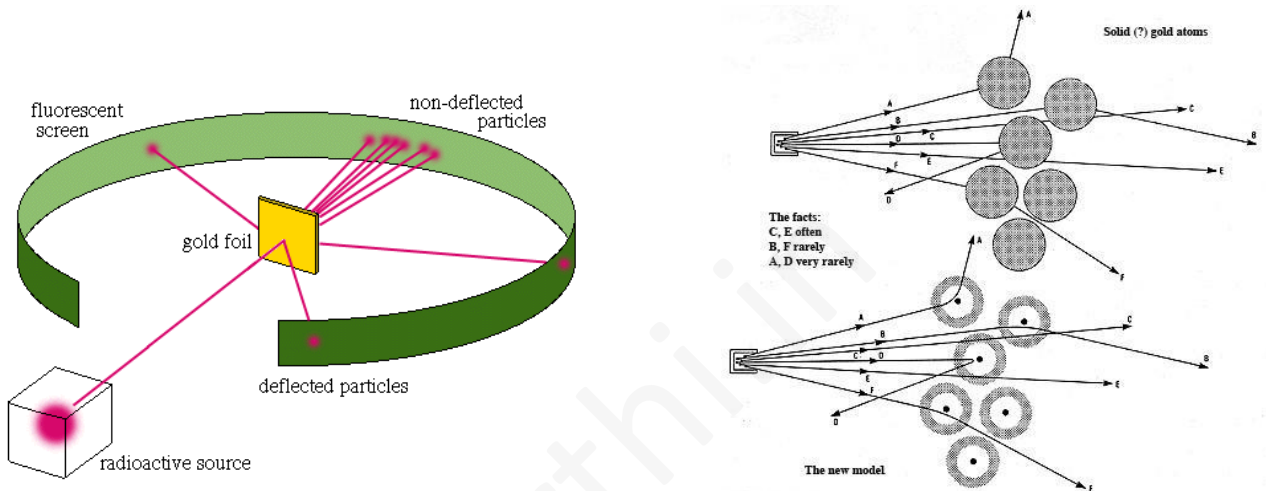

Back-scattering to measure the size of the nucleus

From the known mass and speed of the alpha particles, Rutherford could calculate the distance of closest approach to a nucleus. This is the distance from a gold atom's centre at which an alpha particle making a rare head-on collision would come to rest momentarily and bounce straight back.

Rutherford tried different energy alpha particles, and found some for which the measured number deviated from the predicted number. He suggested that, at this energy, the alpha particles were reaching the nucleus and being assimilated into it. This, he said, gave an indication of the radius of the nucleus. That radius turned out to be 10,000 times smaller than the radius of the atom.

To show that nuclear density is independent of A (or that all nuclei have the same density - or uniform density)

Let the volume of a nucleus be V

the mass of the nucleus be M

and the mass of a nucleon be m

$$V = \frac{4}{3}\pi r^3$$

$$\rho = \frac{M}{V}$$

$$\text{so, } M = \frac{4}{3}\pi r^3 \rho$$

Let's replace the r^3 from the equation

$$r = r_0 A^{1/3}$$

$$r^3 = r_0^3 A$$

$$M = \frac{4}{3}\pi r_0^3 A \rho$$

$$\text{but } M = Am$$

$$\text{So, } Am = \frac{4}{3}\pi r_0^3 A \rho$$

Therefore,

$$\text{Rearranging we get, } \rho = \frac{3m}{(4\pi r_0^3)}$$

This means that the density does not depend on A or r – it is related to constant values – it is therefore a constant value.

OR

- Q19.** Distinguish between nuclear fission and fusion. Show how in both these processes energy is released. Calculate the energy release in MeV in the deuterium-tritium fusion reaction:

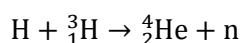

Using the data:

$$m({}^2_1H) \quad \quad \quad u$$

$$m({}^3_1H) = \quad \quad \quad u$$

$$m({}^4_2He) = \quad \quad \quad u$$

$$m_n = 1.008665 u$$

$$1u = 931.5 \text{ MeV}/c^2$$

Sol.19

	Nuclear Fission	Nuclear Fusion
Definition	Fission is the splitting of a large atom into two or more smaller ones	Fusion is the fusing of two or more lighter atoms into a larger one.
Natural occurrence of the process	Fission reaction does not normally occur in nature.	Fusion occurs in stars, such as the sun.
Byproducts of the reaction	Fission produces many highly radioactive particles.	Few radioactive particles are produced by fusion reaction, but if a fission "trigger" is used,

		radioactive particles will result from that.
Conditions	Critical mass of the substance and high-speed neutrons are required.	High density, high temperature environment is required.
Energy Requirement	Take little energy to split two atoms in a fission reaction.	Extremely high energy is required to bring two or more protons close enough that nuclear forces overcome their electrostatic repulsion.
Energy Released	The energy released by fission is a million times greater than that released in chemical reactions; but lower than the energy released by nuclear fusion.	The energy released by fusion is three to four times greater than the energy released by fission.
Nuclear weapon	One class of nuclear weapon is a fission bomb, also known as an atomic bomb or atom bomb.	One class of nuclear weapon is the hydrogen bomb, which uses a fission reaction to “trigger” a fusion reaction.

Since in both the cases, binding energy of the product is higher than those of the reactants, the energy is released. In the process which equal the charge in the Binding energy.

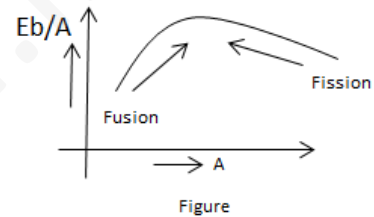

Fusion reaction:



Fission reaction:

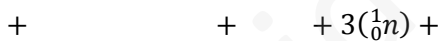

Energy released:

$$(\Delta m)c$$

$$(2 + 665)$$

$$= 17.5895 \text{ MeV.}$$

Q20. Draw a block diagram of a detector for AM signal and show, using necessary processes and the waveforms, how the original message signal is detected from the input AM word.

Sol.20

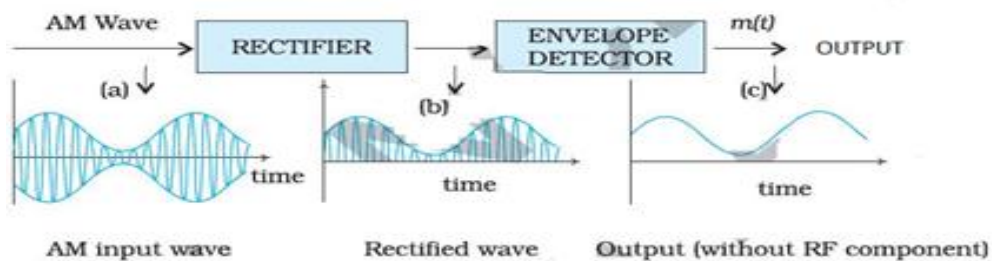

Block diagram of a detector for AM signal.
The quantity on y-axis can be current or voltage.

Q21. A cell of emf 'E' and internal resistance 'r' is connected across a variable load resistor R. Draw the plots of the terminal voltage V versus (i) R and (ii) the current I.

It is found that when $R = 4 \Omega$, the current is 1 A and when R is increased to 9Ω , the current reduces to 0.5 A. Find the values of the emf E and internal resistance r.

Sol.21 $V = E - Ir, V = IR$

$$V = E - Ir \Rightarrow V(1 + \frac{r}{R}) \Rightarrow V = \frac{E R}{R + r}$$

$$V = IR = \frac{E R}{R + r}$$

$$V = IR = \frac{E R}{R + r}$$

$$V = IR = \frac{E R}{R + r}$$

$$\text{So } V = IR = \frac{E R}{R + r}$$

$$R = \frac{E}{V} - r$$

$$\text{But } V = IR$$

$$V = I \left(\frac{E}{V} - r \right)$$

$$E - V = Ir$$

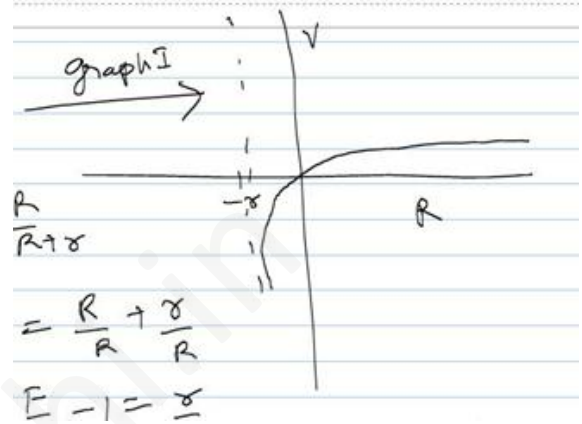

Q22. Two capacitors of unknown capacitances C_1 and C_2 are connected first in series and then in parallel across a battery of 100 V. If the energy stored in the two combinations is 0.045 J and 0.25 J respectively, determine the value of C_1 and C_2 . Also calculate the charge on each capacitor in parallel combination.

Sol.22 When connected in series

$$-\left(\frac{1}{C_1} + \frac{1}{C_2}\right) v$$

When connected in parallel

$$- (C_1 + C_2)v$$

$$\Rightarrow + \quad \quad \quad 50\mu f \quad \dots (1)$$

Using (1),

$$-\left[\frac{1(50 - 1)}{4} \right]$$

$$\Rightarrow (\quad 4)$$

\Rightarrow

$$\Rightarrow 4 \quad +$$

$$\Rightarrow 4 \quad \frac{\pm \sqrt{250}}{\quad}$$

f or f

So, $c_2 = 11.775f$ or $38.23f$

So, two capacitances are $11.78f$ and $38.23f$

Now, change on each capacitance in parallel combination is

$$= (11.78 \times 100)C \quad (\because Q = CV)$$

$$= 1178 C$$

$$= (38.23 \times 100)C$$

$$= 3823 C.$$

Section - D

Q23. A group of students while coming from the school noticed a box marked 'Danger H.T. V' at a substation in the main street. They did not understand the utility of a such a high voltage, while they argued, the supply was only 220 V. They asked their teacher this question the next day. The teacher thought it to be an important question and therefore explained to the questions:

(i) What device is used to bring the high voltage down to low voltage of a.c. current and what is the principle of its working?

(ii) Is it possible to use this device for bringing down the high dc voltage to the low voltage? Explain.

(iii) Write the values displayed by the students and the teacher.

Sol.23 (i) Device is called Transformer.

A transformer makes use of Faraday's law and the ferromagnetic properties of an iron core to efficiently raise or lower AC voltages.

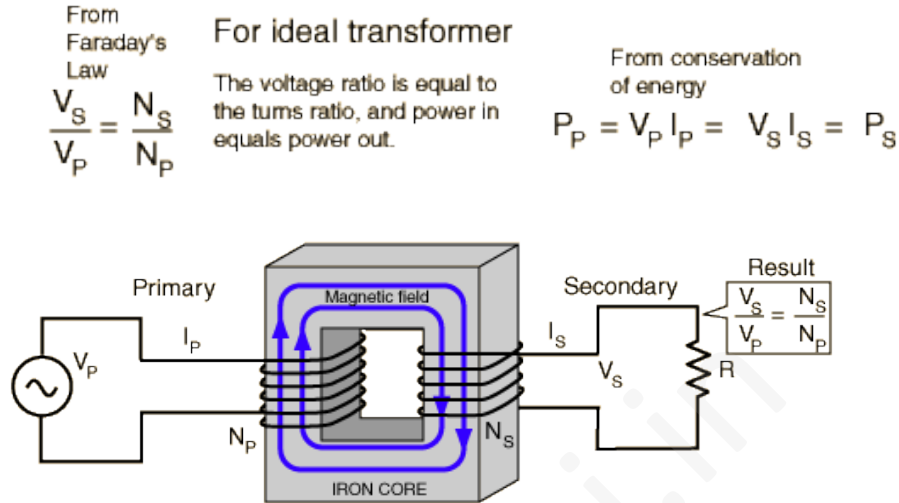

(ii) No. Because there is no change in voltage or current and hence flux through the coils.

(iii) 2200 V is the main voltage supply to the substation from the main source of supply. The substation reduces the voltage from 2200 V to 220 V for safe household uses.

Section – E

Q24. (a) An electric dipole of dipole moment \vec{p} consists of point charges $+q$ and $-q$ separated by a distance $2a$ apart. Deduce the expression for the electric field \vec{E} due to the dipole at a distance x from the centre of the dipole on its axial line in terms of the dipole moment \vec{p} . Hence show that in the limit $x \gg a$, $\vec{E} \rightarrow 2\vec{p}i / (4\pi\epsilon_0 x^3)$

(b) Given the electric field in the region $\vec{E} = E_0 \hat{i}$, find the net electric flux through the cube and the charge enclosed by it.

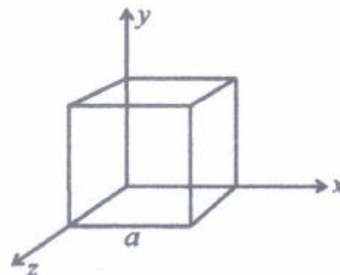

Sol.24

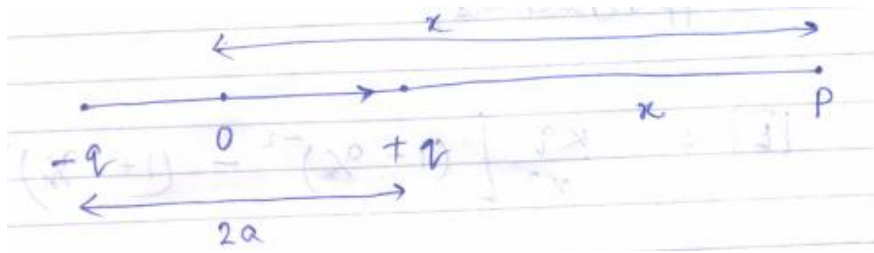

\rightarrow due to $(-q)$ is,

$$\rightarrow \left| = \frac{K(-q)}{(x-a)^2} \right.$$

\rightarrow due to $(+q)$ is,

$$\left| \vec{E}_q \right| = \frac{Kq}{(x-a)^2}$$

So, Net electric field,

$$\rightarrow = \rightarrow + \rightarrow \left| \frac{Kq}{(x-a)^2} - \frac{Kq}{(x-a)^2} \right.$$

$$\Rightarrow \vec{E} = \frac{kq}{2} \left[\frac{1}{(1-x/a)^2} - \frac{1}{(1+x/a)^2} \right]$$

For $x \gg a$, $- \ll 1$, so, using binomial approximation and

$$|\vec{E}| = \frac{kq}{2} \left[(1 - \frac{2x}{a}) - (1 + \frac{2x}{a}) \right]$$

$$= - \left[\frac{2x}{a} - \frac{2x}{a} \right]$$

Neglecting higher order terms

$$= - 2 \left(- \frac{k \cdot (q \times 2a)}{4a^2} \right)$$

(b) $\vec{E} = 2x\hat{i}$

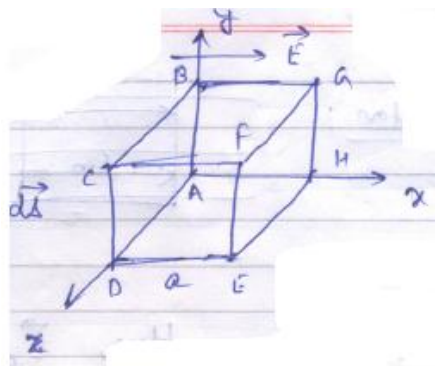

$$\begin{aligned} \text{Electric flux} &= \int \vec{E} \cdot d\vec{s} \\ &= \phi (\text{EFGH}) - \phi (\text{ABCD}) \\ &= 2a (a^2) - 0 (a^2) \\ &= 2a^3 \end{aligned}$$

So, electric flux = $\frac{q_{in}}{\epsilon_0} \Rightarrow q_{in} = 2a^3 \epsilon_0$

OR

Q24. (a) Explain, using suitable diagrams, the difference in the behavior of a (i) conductor and (ii) dielectric in the presence of external electric field. Define the terms polarization of a dielectric and write its relation with susceptibility.

(b) A thin metallic spherical shell of radius R carries a charge Q on its surface. A point charge $-\frac{Q}{2}$ is placed at its centre C and another charge +2Q is placed outside the shell at a distance x from the centre as shown in the figure. Find



(i) The force on the charge at the centre of shell and at the point A, (ii) the electric flux through the shell.

Sol.24 (a) Conduction:

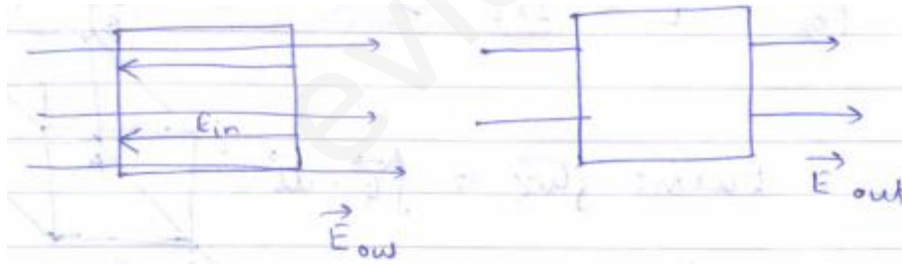

Here, $\vec{E} > \vec{E}_{in}$.

Dielectrics:

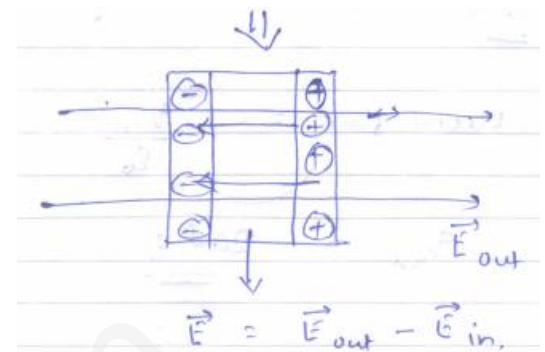
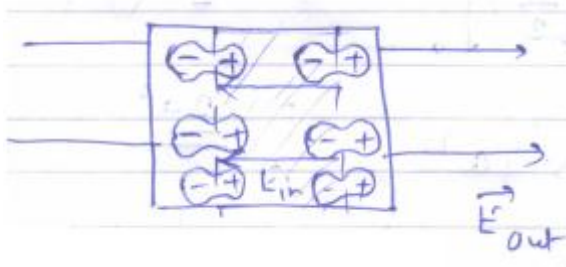

Shaded region has zero change. Here, $\vec{E} = \vec{E}_{out} - \vec{E}_{in}$

$$\vec{E} = \vec{E}_{out} - \vec{E}_{in}$$

Polarization or Polarization density is defined as the average electric dipole moment \vec{p} per unit volume 'V' of the dielectric mutual.

In isotropic dielectric medium,

$$P = \epsilon_0 \chi \vec{E}$$

Here χ = electric susceptibility of the medium.

(b) Charge $-q$ at centre induces a charge $-q$ at the inside surface of the shell and $+q$ at the outside surface. The charge $(+q)$ at the outside surface is unevenly distributed due to charge $+2Q$ at A.



The force experienced by the charge at the centre is zero as the electric field due to all the outside charge is zero inside a metallic shell and vice-versa.

So, the force at A due to all charges is

$$\vec{F} = \frac{K(q)(-q)}{r^2} = \frac{Kq^2}{r^2} \text{ where } K = \frac{1}{4\pi\epsilon_0}$$

The electric flux, $\Phi = \frac{q}{\epsilon_0}$

$$\frac{(+q)}{\epsilon_0}$$

—

Q25. (a) Scale Ampere's circuital law. Use this law to obtain the expression for the magnetic field inside an air cooled forced is average radius 'r' having 'n' turns per unit length and carrying a steady current I.

(b) An observer to the left of a solenoid of N turns each of cross section are 'A' observers that a steady current I in it flows in the clockwise direction. Depict the magnetic field lines due to the solenoid specifying its polarity and show that it acts as a bar magnet of magnetic moment $m = NIA$.

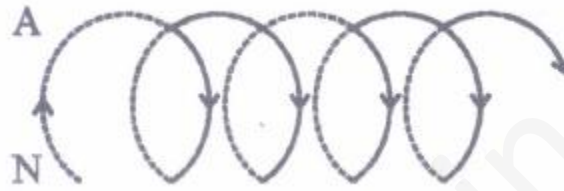

Sol.25 (a) Ampere's Law states that for any closed loop path, the sum of the length elements the magnetic field in the direction of the length element is equal to the permeability times the electric current enclosed in the loop.

	<p>Finding the magnetic field inside a toroid is a good example of the power of Ampere's law. The current enclosed by the dashed line is just the number of loops law then given the magnetic field by</p> $B2\pi r = \mu NI$ $B = \frac{\mu NI}{2\pi r}$
--	---

(b) Magnetic field goes from the viewer's side end to other end inside the solenoid and in opposite direction outside the solenoid.. The side of solenoid near the viewer acts as the South Pole and the farther end of the solenoid acts as the North Pole.

The magnetic field produced by electric current in a solenoid coil is similar to that of a bar magnet.

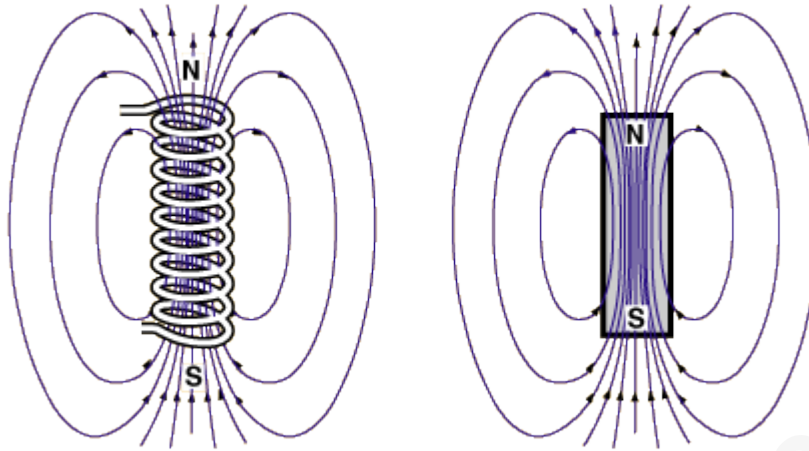

A current-carrying loop placed in an external magnetic field experiences magnetic forces and torque similar to the magnetic compass. For such a current loop that has N turns and placed in the uniform magnetic field, \mathbf{B} , the torque has a magnitude:

$$\tau = NIA (B_{ext}) \sin \theta = \mathbf{mB} \sin \theta$$

So, $\mathbf{M} = NIA$

OR

- Q25.** (a) Define mutual inductance and write its S.I. units
 (b) Derive an expression for the mutual inductance of two long co-axial solenoids of same length wound one over the other
 (c) In an experiment, two coils c_1 and c_2 are placed close to each other. Find out the expressive foe the emf induced in the coil c_1 due to a change in the current through the coil c_2 .

Sol.25 (a) It is the phenomenon in which a change of current in one coil causes an induced emf in another coil placed near to the first coil. S.I Unit = Henry.

(b) Consider, two long thin solenoids, one wound on top of the other. The length of each solenoid is l and the common radius is r . suppose that the bottom coil has N_1 turns per unit length, and carries a current I_1 . The magnetic flux passing through each turn of the top coil is $\mu_0 N_1 I_1 \pi r^2$, and the total flux linking the top coil is therefore $\phi_2 = N_2 \mu_0 N_1 I_1 \pi r^2$, where N_2 is the number of turns per unit length in the top coil. It follows that the mutual inductance of the two coils, defined $\phi_2 = M I_1$, is given by

$M = \mu_0 N_1 N_2 \pi r^2 l$ Suppose two coils are placed near each other, as shown in Figure.

(c) Suppose two coils are placed near each other, as shown in Figure.

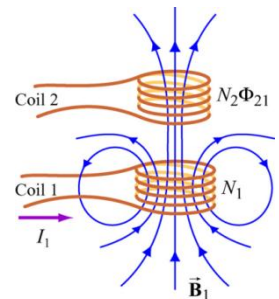

Figure: Changing current in coil 1 produces changing magnetic flux in coil 2.

The c_2 has N_2 turns and carries a current I_2 which gives rise to a magnetic field B_2 .

Since the two coils are close to each other, some of the magnetic field lines through coil c_2 will also pass through coil c_1 . Let Φ_{21} denote the magnetic flux through one turn of coil 1 due to I_2 . Now, by varying I_2 with time, there will be an induced emf associated with the changing magnetic flux in the c_1 coil.

The time rate of change of magnetic flux Φ_{21} in coil c_1 is proportional to the time rate of change of the current in coil 2: $e_2 = M \cdot dI_2/dt = N_2 \cdot d\Phi_{21}/dt$

- Q26.** (a) Using Huygens's construction of secondary wavelets explain how a diffraction pattern is obtained as a screen due to a narrow slit on which a monochromatic beam of light is incident normally.
- (b) Show that the angular width of the first diffraction fringe is half of the central fringe.
- (c) Explain why the maxima at $\theta = (n + \frac{1}{2})\lambda$ become weaker and weaker with increasing n .

Sol.26 (a)



(b) Angular width of first central fringe

First minima occurs when

$$d \sin \theta = \lambda$$

Since, ' θ ' is small,

$$\sin \theta \approx \tan \theta \approx \frac{y}{D}$$

$$\Rightarrow y = \frac{\lambda D}{d}$$

So width of central maxima = $(-)$ $\times 2 = \text{---}$

Second minima occurs when,

$$d \sin \theta = 2\lambda = d \tan \theta$$

$$\text{so, } \Rightarrow \tan \theta \text{ ---} \Rightarrow y' \text{ ---}$$

width of first maxima = $\text{---} \text{---} \text{---}$

so, width of first maxima = --- (width of central minima)

(c) Maxima because weaver and weaver due to decreasing intensity of wave fronts as we more farther away from the slit. As the intensity over the spherical surface decreases as inverse square, intensity decreases.

OR

- Q26.** (a) A point object 'O' is kept in a medium of refractive index n_1 in front of a convex spherical surface of radius of curvature R which separates the second medium of refractive index n_2 from the first one, as shown in the figure.

Draw the ray diagram showing the image formation and deduce the relationship between the object distance and the image distance in terms of n_1 , n_2 and R.

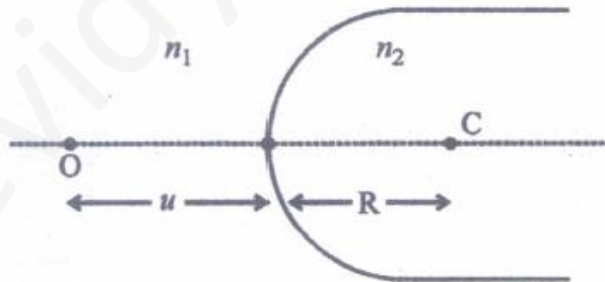

(b) When the image formed above acts as a virtual object for a concave spherical surface separating the medium n_2 from n_1 ($n_2 > n_1$), draw this ray diagram and write the similar (similar to (a)) relation. Hence obtain the expression for the lens maker's formula.

Sol.26 (a) O: Point object, $OP = u =$ Object Distance

P: Pole, C: centre of curvature, $PC = R =$ Radius of curvature I: Point image, $PI = v =$ image distance

$i, r, \alpha, \beta, \gamma$ are small enough for $\sin i \sim i \sim \tan i$ to hold etc.

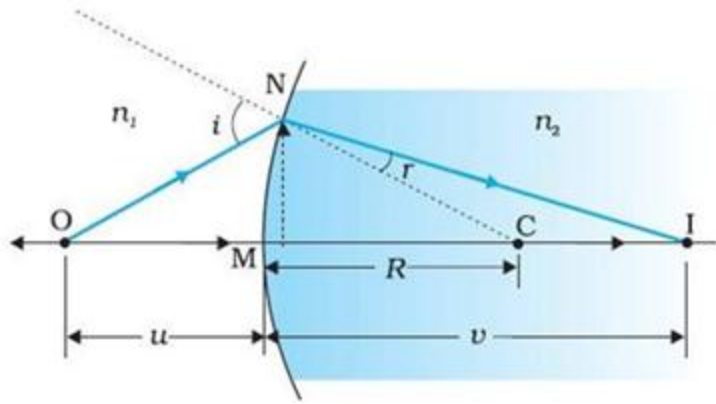

n_1 and n_2 refractive indices of rarer & denser media (with respect to vacuum or air as incidence medium):

i.e. $1\mu_2 = \dots$ but $\sin i \approx i, \sin r \approx r$

$\therefore \dots$

$\therefore n_1 i = n_2 r$

But $I = \alpha + \gamma$ & $\gamma = r + \beta$ i.e. $r = \gamma - \beta$

$\therefore n_1 (\alpha + \gamma) = n_2 (\gamma - \beta)$

$n_1 \alpha + n_2 \beta = (n_2 - n_1) \gamma$

$n_1 \tan \alpha + n_2 \tan \beta = (n_2 - n_1) \tan \gamma$

$\therefore n_1 \left(\frac{h}{u}\right) + n_2 \left(\frac{h}{v}\right) = (n_2 - n_1) \left(\frac{h}{R}\right)$

$\therefore \dots + \dots = \dots$

But $OQ \approx PQ = u, QI \approx v, QC \approx PC = R$

$\therefore \dots + \dots = \dots$

But u is negative v, R are positive

$\therefore \dots + \dots = \dots$

$\therefore \dots - \dots = \dots \dots \dots (9)$

(b) In the figure, change n_1 by n_2 and vice versa.

Let us assume the v from last equation as v' and its radius of curvature as R_1 .

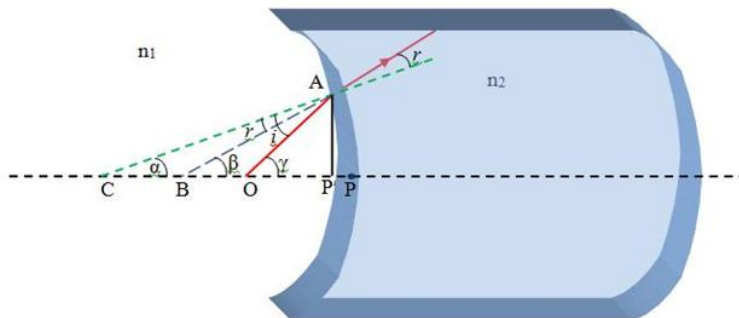

— — —

— — + —

Now O' acts as the virtual object for the refraction at convex surface

Now here

Object distance = v'

Image distance = v

Radius of convex surface = R_2

Applying the formula for denser to rarer medium

— — —

By eqn. 1 and eqn. 2

$$- \left(\frac{1}{v'} + \frac{1}{v} \right) = \frac{1}{R_2} \left(\frac{n_2}{n_1} - 1 \right)$$

$$\Rightarrow n_1 \left(- \frac{1}{v'} - \frac{1}{v} \right) = \frac{n_2 - n_1}{R_2}$$

$$\Rightarrow \left(- \frac{1}{v'} - \frac{1}{v} \right) = \left(\frac{n_2}{n_1} - 1 \right) \left(- \frac{1}{R_2} \right)$$

$$\Rightarrow \left(- \frac{1}{v'} - \frac{1}{v} \right) = \left(\frac{n_2}{n_1} - 1 \right) \left(- \frac{1}{R_2} \right)$$