

AIPMT

SAMPLE PAPERS WITH SOLUTIONS

1. Which two of the following five physical parameters have the same dimensions?

- | | |
|-------------------------|----------------------|
| (a) energy density | (b) refractive index |
| (c) dielectric constant | (d) Young's modulus |
| (e) magnetic field | |
| (1) (a) and (e) | (2) (b) and (d) |
| (3) (c) and (e) | (4) (a) and (d) |

Sol. Answer (4)

Energy density and Young's modulus have same dimensional formula.

2. If the error in the measurement of radius of a sphere is 2%, then the error in the determination of volume of the sphere will be

- | | |
|--------|--------|
| (1) 2% | (2) 4% |
| (3) 6% | (4) 8% |

Sol. Answer (3)

$$\frac{\Delta V}{V} = \frac{3\Delta R}{R}$$

3. The distance travelled by a particle starting from rest and moving with an acceleration $\frac{4}{3} \text{ ms}^{-2}$, in the third second is

- | | |
|------------------------------|------------------------------|
| (1) $\frac{19}{3} \text{ m}$ | (2) 6 m |
| (3) 4 m | (4) $\frac{10}{3} \text{ m}$ |

Sol. Answer (4)

$$S_{n^{\text{th}}} = u + \frac{a}{2}(2n - 1)$$

4. A particle moves in a straight line with a constant acceleration. It changes its velocity from 10 ms^{-1} to 20 ms^{-1} while passing through a distance 135 m in t second. The value of t is

- (1) 9
- (2) 10
- (3) 1.8
- (4) 12

Sol. Answer (1)

$$a = \frac{V_f^2 - V_i^2}{2S}, t = \frac{V_f - V_i}{a}$$

$$\text{or } S = \frac{1}{2} (u + v) t$$

5. A particle shows distance-time curve as given in this figure. The maximum instantaneous velocity of the particle is around the point

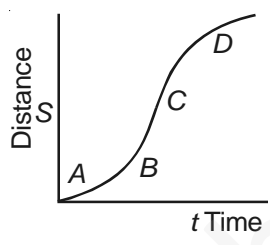

- (1) A
- (2) B
- (3) C
- (4) D

Sol. Answer (3)

Maximum slope is at C.

6. A particle of mass m is projected with velocity v making an angle of 45° with the horizontal. When the particle lands on the level ground the magnitude of the change in its momentum will be

- (1) zero
- (2) $2mv$
- (3) $mv/\sqrt{2}$
- (4) $mv\sqrt{2}$

Sol. Answer (4)

$$\text{Momentum change} = 2mv \sin\theta$$

7. Sand is being dropped on a conveyor belt at the rate of $M \text{ kg/s}$. The force necessary to keep the belt moving with a constant velocity of $v \text{ m/s}$ will be

- (1) Zero
- (2) Mv newton
- (3) $2Mv$ newton
- (4) $\frac{Mv}{2}$ newton

Sol. Answer (2)

$$\text{Force} = v \frac{du}{dt} = Mv$$

8. Three forces acting on a body are shown in the figure. To have the resultant force only along the y-direction, the magnitude of the minimum additional force needed is

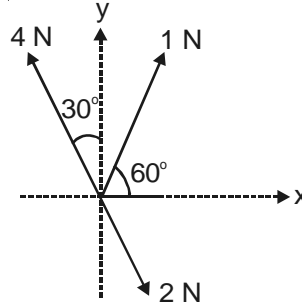

- (1) $\sqrt{3}$ N (2) 0.5 N
(3) 1.5 N (4) $\frac{\sqrt{3}}{4}$ N

Sol. Answer (2)

Net force along x-axis zero.

Let the unknown force be F along x-axis

$$\therefore F + 1 \sin 30^\circ + 2 \sin 30^\circ - 4 \sin 30^\circ = 0$$

$$\therefore |F| = 0.5 \text{ N}$$

9. Water falls from a height of 60 m at the rate of 15 kg/s to operate a turbine. The losses due to frictional forces are 10% of energy. How much power is generated by the turbine? ($g = 10 \text{ m/s}^2$)

- (1) 7.0 kW (2) 8.1 kW
(3) 10.2 kW (4) 12.3 kW

Sol. Answer (2)

$$P = 0.9 \text{ gH } \frac{dm}{dt}$$

10. A shell of mass 200 gm is ejected from a gun of mass 4 kg by an explosion that generates 1.05 kJ of energy. The initial velocity of the shell is

- (1) 120 ms^{-1}
(2) 100 ms^{-1}
(3) 80 ms^{-1}
(4) 40 ms^{-1}

Sol. Answer (2)

Let the initial velocity of the shell be v , then velocity of gun is $\left(\frac{0.2v}{4}\right)$. (from conservation of linear moment)

$$\text{Now } 1.05 \times 10^3 = \frac{1}{2} (0.2) v^2 + \frac{1}{2} (4) \left(\frac{0.2v}{4}\right)^2 \Rightarrow v = 100 \text{ m/s}$$

11. The ratio of the radii of gyration of a circular disc to that of a circular ring, each of same mass and radius, around their respective axes is

- (1) $\sqrt{2} : \sqrt{3}$
- (2) $\sqrt{3} : \sqrt{2}$
- (3) $1 : \sqrt{2}$
- (4) $\sqrt{2} : 1$

Sol. Answer (3)

$$\frac{I_{\text{disc}}}{I_{\text{ring}}} = \frac{MR^2/2}{MR^2} = \frac{MK_{\text{disc}}^2}{MK_{\text{ring}}^2}$$

$$\Rightarrow \frac{K_{\text{disc}}}{K_{\text{ring}}} = \frac{1}{\sqrt{2}}$$

12. A thin rod of length L and mass M is bent at its midpoint into two halves so that the angle between them is 90° . The moment of inertia of the bent rod about an axis passing through the bending point and perpendicular to the plane defined by the two halves of the rod is

- (1) $\frac{\sqrt{2} ML^2}{24}$
- (2) $\frac{ML^2}{24}$
- (3) $\frac{ML^2}{12}$
- (4) $\frac{ML^2}{6}$

Sol. Answer (3)

Distribution of masses about axis of rotation remain unchanged whether it is straight or bend.

$$I = \frac{ML^2}{12}$$

13. A roller coaster is designed such that riders experience "weightlessness" as they go round the top of a hill whose radius of curvature is 20 m. The speed of the car at the top of the hill is between

- (1) 13 m/s and 14 m/s
- (2) 14 m/s and 15 m/s
- (3) 15 ms/ and 16 m/s
- (4) 16 m/s and 17 m/s

Sol. Answer (2)

Actually,

$$mg - N = \frac{mv^2}{r}$$

For weightlessness, $N = 0$

$$\therefore mg = \frac{mv^2}{r}$$

$$v = \sqrt{gr}$$

$$= \sqrt{10 \times 20} \text{ ms}^{-1} = 14.14 \text{ ms}^{-1}$$

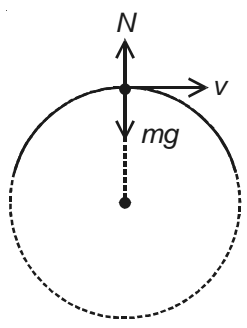



14. If Q , E and W denote respectively the heat added, change in internal energy and the work done in a closed cycle process, then

- (1) $Q = 0$ (2) $W = 0$
 (3) $Q = W = 0$ (4) $E = 0$

Sol. Answer (4)

From the 1st law of thermodynamics,

$$Q = E + W$$

For cyclic process, $E = 0$, $\therefore Q = W \neq 0$

15. On a new scale of temperature (which is linear) and called the W scale, the freezing and boiling points of water are $39^\circ W$ and $239^\circ W$ respectively. What will be the temperature on the new scale, corresponding to a temperature of $39^\circ C$ on the Celsius scale?

- (1) $139^\circ W$ (2) $78^\circ W$
 (3) $117^\circ W$ (4) $200^\circ W$

Sol. Answer (3)

$$\frac{39 - 0}{100 - 0} = \frac{x - 39}{239 - 39}$$

$$\Rightarrow x = 117^\circ W$$

16. At $10^\circ C$ the value of the density of a fixed mass of an ideal gas divided by its pressure is x . At $110^\circ C$ this ratio is

- (1) $\frac{283}{383}x$ (2) x
 (3) $\frac{383}{283}x$ (4) $\frac{10}{110}x$

Sol. Answer (1)

$$PV = nRT$$

$$\Rightarrow P \cdot \frac{m}{\rho} = \frac{m}{M} RT$$

$$\Rightarrow \frac{\left(\frac{\rho}{P}\right)_f}{\left(\frac{\rho}{P}\right)_i} = \frac{T_i}{T_f} = \frac{10 + 273}{110 + 273} = \frac{283}{383}$$

$$\Rightarrow \frac{\left(\frac{\rho}{P}\right)_f}{x} = \frac{283}{383}$$

$$\therefore \left(\frac{\rho}{P}\right)_f = \frac{283}{383}x$$

17. Two Simple Harmonic Motions of angular frequency 100 and 1000 rad s⁻¹ have the same displacement amplitude. The ratio of their maximum accelerations is

- (1) 1 : 10⁴
- (2) 1 : 10
- (3) 1 : 10²
- (4) 1 : 10³

Sol. Answer (3)

$$\frac{(a_{\max})_1}{(a_{\max})_2} = \frac{\omega_1^2 A}{\omega_2^2 A} = \left(\frac{100}{1000}\right)^2 = \frac{1}{10^2}$$

18. The wave described by $y = 0.25 \sin(10 \pi x - 2 \pi t)$, where x and y are in meters and t in seconds, is a wave travelling along the

- (1) -ve x direction with amplitude 0.25 m and wavelength $\lambda = 0.2$ m
- (2) -ve x direction with frequency 1 Hz
- (3) +ve x direction with frequency π Hz and wavelength $\lambda = 0.2$ m
- (4) +ve x direction with frequency 1 Hz and wavelength $\lambda = 0.2$ m

Sol. Answer (4)

Give, $y = 0.25 \sin (10 \pi x - 2\pi t)$

Comparing with $y = A \sin\left(\frac{2\pi}{\lambda} \cdot x - 2\pi n t\right)$, we get,

$\lambda = 0.2$ m

$n = 1$ Hz, -ve sign indicates, the x direction.

19. A point performs simple harmonic oscillation of period T and the equation of motion is given by $x = a \sin(\omega t + \pi/6)$. After the elapse of what fraction of the time period the velocity of the point will be equal to half of its maximum velocity?

- (1) $\frac{T}{12}$
- (2) $\frac{T}{8}$
- (3) $\frac{T}{6}$
- (4) $\frac{T}{3}$

Sol. Answer (1)

$$v = \omega a \cos\left(\omega t + \frac{\pi}{6}\right)$$

$$\Rightarrow \frac{\omega a}{2} = \omega a \cos\left(\frac{2\pi}{T} t + \frac{\pi}{6}\right)$$

$$\Rightarrow \frac{\pi}{3} = \frac{2\pi}{T} t + \frac{\pi}{6}$$

$$\Rightarrow t = \frac{T}{12}$$

20. Two points are located at a distance of 10 m and 15 m from the source of oscillation. The period of oscillation is 0.05 sec and the velocity of the wave is 300 m/sec. What is the phase difference between the oscillations of two points?

- (1) $\frac{\pi}{6}$ (2) $\frac{\pi}{3}$
 (3) $\frac{2\pi}{3}$ (4) π

Sol. Answer (3)

$$\begin{aligned} \text{Phase difference } \phi &= \frac{2\pi}{\lambda} \times \text{path difference} \\ &= \frac{2\pi}{15} \times (15 - 10) \quad \{\lambda = vT = 300 \times 0.05 \text{ m}\} \\ &= \frac{2\pi}{5} \end{aligned}$$

21. The velocity of electromagnetic radiation in a medium of permittivity ϵ_0 and permeability μ_0 is given by

- (1) $\sqrt{\frac{\mu_0}{\epsilon_0}}$ (2) $\sqrt{\frac{\epsilon_0}{\mu_0}}$
 (3) $\sqrt{\mu_0 \epsilon_0}$ (4) $\frac{1}{\sqrt{\mu_0 \epsilon_0}}$

Sol. Answer (4)

$$v = \frac{1}{\sqrt{\mu_0 \epsilon_0}}$$

22. Two periodic waves of intensities I_1 and I_2 pass through a region at the same time in the same direction. The sum of the maximum and minimum intensities is

- (1) $2(I_1 + I_2)$ (2) $I_1 + I_2$
 (3) $(\sqrt{I_1} + \sqrt{I_2})^2$ (4) $(\sqrt{I_1} - \sqrt{I_2})^2$

Sol. Answer (1)

$$\begin{aligned} I_{\max} &= (\sqrt{I_1} + \sqrt{I_2})^2 \\ I_{\min} &= (\sqrt{I_1} - \sqrt{I_2})^2 \\ \therefore I_{\max} + I_{\min} &= 2(I_1 + I_2) \end{aligned}$$

23. Two thin lenses of focal lengths f_1 and f_2 are in contact and coaxial. The power of the combinations is

- (1) $\frac{f_1 + f_2}{f_1 f_2}$ (2) $\sqrt{\frac{f_1}{f_2}}$
 (3) $\sqrt{\frac{f_2}{f_1}}$ (4) $\frac{f_1 + f_2}{2}$

$$\frac{1}{f} = \frac{1}{f_1} + \frac{1}{f_2}$$

$$\Rightarrow P = \frac{f_1 + f_2}{f_1 f_2}$$

24. A boy is trying to start a fire by focusing Sunlight on a piece of paper using an equiconvex lens of focal length 10 cm. The diameter of the Sun is 1.39×10^9 m and its mean distance from the earth is 1.5×10^{11} m. What is the diameter of the Sun's image on the paper?

- (1) 12.4×10^{-4} m
- (2) 9.2×10^{-4} m
- (3) 6.5×10^{-4} m
- (4) 6.5×10^{-5} m

Sol. Answer (2)

Here, $\frac{D/2}{u} = \frac{d/2}{f}$

$$\Rightarrow d = \frac{Df}{u}$$

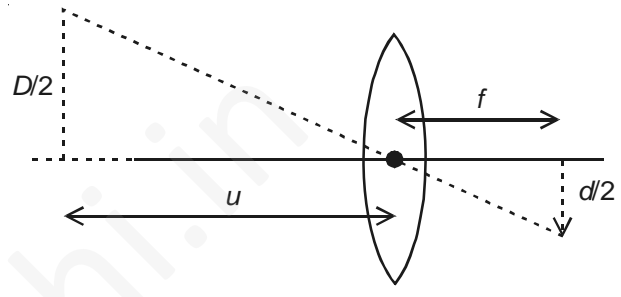

$$= \frac{1.39 \times 10^9 \times 10 \times 10^{-2}}{1.5 \times 10^{11}} = 9.2 \times 10^{-4} \text{ m}$$

25. The energy required to charge a parallel plate condenser of plate separation d and plate area of cross-section A such that the uniform electric field between the plates is E , is

- (1) $\frac{1}{2} \epsilon_0 E^2 Ad$
- (2) $\frac{1}{2} \epsilon_0 E^2 / A.d$
- (3) $\epsilon_0 E^2 / Ad$
- (4) $\epsilon_0 E^2 Ad$

Sol. Answer (1)

$$\text{Energy required} = \frac{1}{2} CV^2 = \frac{1}{2} \epsilon_0 E^2 Ad$$

26. A thin conducting ring of radius R is given a charge $+Q$. The electric field at the centre O of the ring due to the charge on the part AKB of the ring is E . The electric field at the centre due to the charge on the part $ACDB$ of the ring is

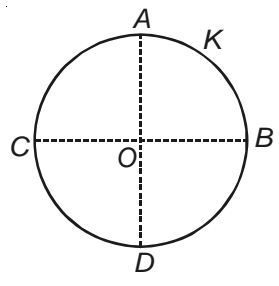

- (1) $3 E$ along OK
- (2) $3 E$ along KO
- (3) E along OK
- (4) E along KO

$$\vec{E}_0 = 0$$

$$\vec{E}_{AKB} + \vec{E}_{ACDB} = 0$$

$$\Rightarrow \vec{E}_{ACDB} = (-)\vec{E}_{AKB}$$

$$= -E \text{ (along KO)}$$

$$= E \text{ (along OK)}$$

27. The electric potential at a point in free space due to a charge Q coulomb is $Q \times 10^{11}$ volts. The electric field at that point is

- (1) $12\pi\epsilon_0 Q \times 10^{22}$ volt/m
- (2) $4\pi\epsilon_0 Q \times 10^{22}$ volt/m
- (3) $12\pi\epsilon_0 Q \times 10^{20}$ volt/m
- (4) $4\pi\epsilon_0 Q \times 10^{20}$ volt/m

Sol. Answer (2)

$$V = \frac{1}{4\pi\epsilon_0} \cdot \frac{Q}{R} = Q \times 10^{11} \text{ volt} \quad \dots(i)$$

$$E = \frac{1}{4\pi\epsilon_0} \cdot \frac{Q}{R^2} = \frac{V}{R} = Q \times 10^{11} \times 4\pi\epsilon_0 \times 10^{11} \text{ [from ... (i)]}$$

$$= 4\pi\epsilon_0 Q \times 10^{22} \text{ volt/m}$$

28. A cell can be balanced against 110 cm and 100 cm of potentiometer wire, respectively with and without being short circuited through a resistance of 10Ω . Its internal resistance is

- (1) Zero
- (2) 1.0 ohm
- (3) 0.5 ohm
- (4) 2.0 ohm

Sol. Answer (2)

$$\text{Internal resistance} = \left(\frac{110}{100} - 1 \right) \times 10\Omega$$

29. A wire of a certain material is stretched slowly by ten per cent. Its new resistance and specific resistance become respectively

- (1) 1.1 times, 1.1 times
- (2) 1.2 times, 1.1 times
- (3) 1.21 times, same
- (4) Both remain the same

Sol. Answer (3)

$$\frac{R_2}{R_1} = \left(\frac{l_2}{l_1} \right)^2 = \left(\frac{1.1 l_1}{l_1} \right)^2 = 1.21$$

$$R_2 = 1.21 R$$

specific resistance is material property which remains unchanged here.

30. In the circuit shown, the current through the 4Ω resistor is 1 amp when the points P and M are connected to a d.c. voltage source. The potential difference between the points M and N is

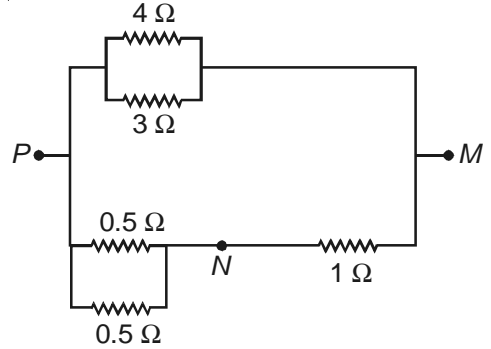

- (1) 3.2 volt
- (2) 1.5 volt
- (3) 1.0 volt
- (4) 0.5 volt

Sol. Answer (1)

Potential difference between P and $M = 1 \times 4 = 4$ volt

Potential drop between points M and $N = \frac{4 \times 1}{1 + 0.25} = 3.2$ V

31. An electric kettle takes 4A current at 220 V. How much time will it take to boil 1 kg of water from temperature 20°C ? The temperature of boiling water is 100°C .

- (1) 4.2 min
- (2) 6.3 min
- (3) 8.4 min
- (4) 12.6 min

Sol. Answer (2)

$Vit = mc\Delta\theta$

$t = \frac{1 \times 4200 \times 80}{220 \times 4} = 381.8 \text{ s} = 6.36 \text{ min}$

32. A current of 3 amp. flows through the 2Ω resistor shown in the circuit. The power dissipated in the 5Ω resistor is

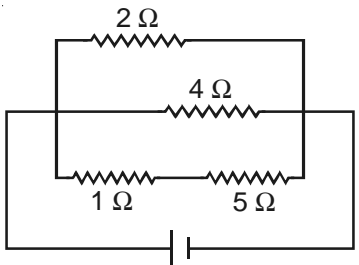

- (1) 5 watt
- (2) 4 watt
- (3) 2 watt
- (4) 1 watt

Sol. Answer (1)

Potential difference across $2\Omega = 6\text{V}$

Current through $5\Omega = \frac{6}{6} = 1\text{A}$

Power dissipated in $5\Omega = (1)^2 \times 5 = 5 \text{ Watt}$

FREE Education

33. A particle of mass m , charge Q and kinetic energy T enters a transverse uniform magnetic field of induction

- \vec{B} . After 3 seconds the kinetic energy of the particle will be
- (1) $4 T$ (2) $3 T$
 (3) $2 T$ (4) T

Sol. Answer (4)

Work done by magnetic field on charge particle is zero. Therefore its kinetic energy will be same i.e. T

34.

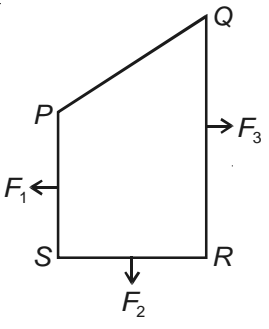

A closed loop $PQRS$ carrying a current is placed in a uniform magnetic field. If the magnetic forces on segments PS , SR and RQ are F_1 , F_2 and F_3 respectively and are in the plane of the paper and along the directions shown, the force on the segment QP is

- (1) $F_3 - F_1 + F_2$ (2) $F_3 - F_1 - F_2$
 (3) $\sqrt{(F_3 - F_1)^2 + F_2^2}$ (4) $\sqrt{(F_3 - F_1)^2 - F_2^2}$

Sol. Answer (3)

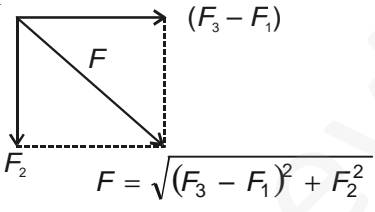

Since net force on current carrying loop in uniform magnetic field is zero therefore force on remaining segment will be equal and opposite to F .

35. A circular disc of radius 0.2 meter is placed in a uniform magnetic field of induction $\frac{1}{\pi} \left(\frac{\omega b}{m^2} \right)$ in such a way

that its axis makes an angle of 60° with \vec{B} . The magnetic flux linked with the disc is

- (1) $0.01 \omega b$ (2) $0.02 \omega b$
 (3) $0.06 \omega b$ (4) $0.08 \omega b$

Sol. Answer (2)

$$\text{Magnetic flux} = BA \cos\theta = \frac{1}{\pi} \times \pi(0.2)^2 \times \cos 60^\circ$$

$$= 0.04 \times \frac{1}{2} = 0.02 \omega b$$

36. A galvanometer of resistance 50Ω is connected to a battery of 3 V along with a resistance of 2950Ω in series. A full scale deflection of 30 divisions is obtained in the galvanometer. In order to reduce this deflection to 20 divisions, the resistance in series should be

- (1) 4450Ω
- (2) 5050Ω
- (3) 5550Ω
- (4) 6050Ω

Sol. Answer (1)

$$30 i_0 = \frac{V}{R_g + 2950}; R_g = 50\Omega$$

$$20 i_0 = \frac{V}{R_g + R} \Rightarrow R = 4450\Omega$$

37. Curie temperature is the temperature above which
- (1) Ferromagnetic material becomes diamagnetic material
 - (2) Ferromagnetic material becomes paramagnetic material
 - (3) Paramagnetic material becomes diamagnetic material
 - (4) Paramagnetic material becomes ferromagnetic material

Sol. Answer (2)

Above curie temperature domains break down, hence ferromagnetic substances become paramagnetic.

38. A long solenoid has 500 turns. When a current of 2 ampere is passed through it, the resulting magnetic flux linked with each turn of the solenoid is $4 \times 10^{-3} \text{ wb}$. The self-inductance of the solenoid is

- (1) 4.0 henry
- (2) 2.5 henry
- (3) 2.0 henry
- (4) 1.0 henry

$$N\phi = Li$$

$$500 \times 4 \times 10^{-3} = 2L$$

$$L = 1.0 \text{ henry}$$

Sol. Answer (4)

39. In an a.c. circuit the e.m.f. (e) and the current (i) at any instant are given respectively by

$$e = E_0 \sin \omega t$$

$$i = I_0 \sin(\omega t - \phi)$$

The average power in the circuit over one cycle of a.c. is

- (1) $E_0 I_0$
- (2) $\frac{E_0 I_0}{2}$
- (3) $\frac{E_0 I_0}{2} \sin \phi$
- (4) $\frac{E_0 I_0}{2} \cos \phi$

Sol. Answer (4)

Since phase difference between current and e.m.f is ϕ

$$\therefore P_{av} = \frac{E_0 I_0}{2} \cos \phi$$

40. In the phenomenon of electric discharge through gases at low pressure, the coloured glow in the tube appears as a result of

- (1) Collision between different electrons of the atoms of the gas
- (2) Excitation of electrons in the atoms
- (3) Collision between the atoms of the gas
- (4) Collisions between the charged particles emitted from the cathode and the atoms of the gas

Sol. Answer (2)

Due to excitation of electrons in atoms.

41. The work function of a surface of a photosensitive material is 6.2 eV. The wavelength of the incident radiation for which the stopping potential is 5 V lies in the

- (1) X-ray region
- (2) Ultraviolet region
- (3) Visible region
- (4) Infrared region

Sol. Answer (2)

$$eV_0 = E - \phi$$

$$E = eV_0 + \phi$$

$$= 5eV + 6.2 eV$$

$$= 11.2 eV$$

$$\therefore \lambda = \left(\frac{12400}{11.2} \right) \text{ \AA} \approx 1000 \text{ \AA}$$

⇒ hence lies in ultraviolet region.

42. A particle of mass 1 mg has the same wavelength as an electron moving with a velocity of $3 \times 10^6 \text{ ms}^{-1}$. The velocity of the particle is (mass of electron = $9.1 \times 10^{-31} \text{ kg}$)

- (1) $2.7 \times 10^{-21} \text{ ms}^{-1}$
- (2) $2.7 \times 10^{-18} \text{ ms}^{-1}$
- (3) $9 \times 10^{-2} \text{ ms}^{-1}$
- (4) $3 \times 10^{-31} \text{ ms}^{-1}$

Sol. Answer (2)

Same momentum of both particles

$$1 \times 10^{-3} \times v = 9 \times 10^{-31} \times 3 \times 10^6$$

$$v = 2.7 \times 10^{-18} \text{ m/s}$$

43. The ground state energy of hydrogen atom is -13.6 eV . When its electron is in the first excited state, its excitation energy is

- (1) 0
- (2) 3.4 eV
- (3) 6.8 eV
- (4) 10.2 eV

Sol. Answer (4)

$$\text{Excitation energy} = E_f - E_i$$

$$= -3.4 - (-13.6) = 10.2 \text{ eV}$$

44. Two radioactive materials X_1 and X_2 have decay constants 5λ and λ respectively. If initially they have the same number of nuclei, then the ratio of the number of nuclei of X_1 to that of X_2 will be $\frac{1}{e}$ after a time

- (1) $\frac{e}{\lambda}$
- (2) λ
- (3) $\frac{1}{2}\lambda$
- (4) $\frac{1}{4\lambda}$

Sol. Answer (4)

$$\frac{N_{x_1}}{N_{x_2}} = \frac{e^{-5\lambda t}}{e^{-\lambda t}} = \frac{1}{e}$$

$$\Rightarrow t = \frac{1}{4\lambda}$$

45. Two nuclei have their mass numbers in the ratio of 1:3. The ratio of their nuclear densities would be

- (1) 1 : 1
- (2) 1 : 3
- (3) 3 : 1
- (4) $(3)^{1/3} : 1$

Sol. Answer (1)

Density is independent of mass number of nuclei.

46. If $M(A, Z)$, M_p and M_n denote the masses of the nucleus ${}_Z^A X$, proton and neutron respectively in units of u ($1u = 931.5 \text{ MeV} / C^2$) and BE represents its bonding energy in MeV, then

- (1) $M(A, Z) = ZM_p + (A - Z) M_n + BE / C^2$
- (2) $M(A, Z) = ZM_p + (A - Z) M_n - BE / C^2$
- (3) $M(A, Z) = ZM_p + (A - Z) M_n + BE$
- (4) $M(A, Z) = ZM_p + (A - Z) M_n - BE$

Sol. Answer (2)

$$BE = [ZM_p + (A - Z) M_n - M(A, Z)] C^2$$

47. The voltage gain of an amplifier with 9% negative feedback is 10. The voltage gain without feedback will be

- (1) 100
- (2) 90
- (3) 10
- (4) 1.25

Sol. Answer (1)

Given

$$\frac{v_o}{v_i} = 10$$

and $(v_i - 0.09 v_o) A = v_o$

$\Rightarrow A = 100$

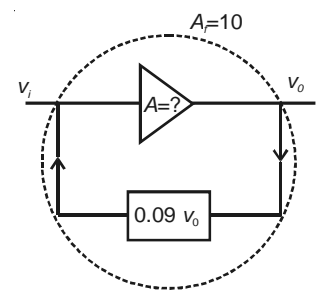

48. If the lattice parameter for a crystalline structure is 3.6 \AA , then the atomic radius in fcc crystal is

- (1) 1.27 \AA
- (2) 1.81 \AA
- (3) 2.10 \AA
- (4) 2.92 \AA

Sol. Answer (1)

$$2R = \frac{a}{\sqrt{2}}$$

$$\therefore R = \frac{a}{2\sqrt{2}}$$

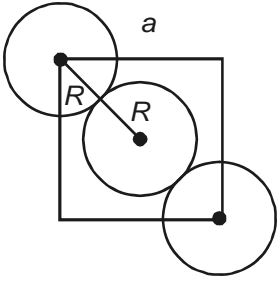

49. The circuit

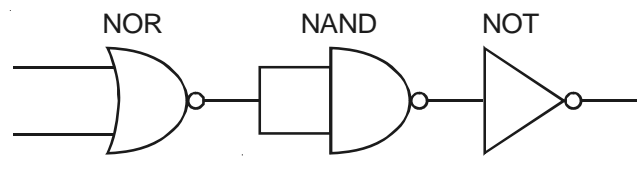

is equivalent to

- (1) OR gate
- (2) AND gate
- (3) NAND gate
- (4) NOR gate

Sol. Answer (4)

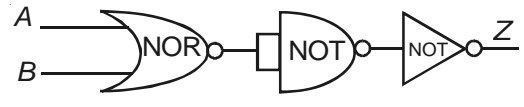

A	B	Z
0	0	1
0	1	0
1	0	0
1	1	0

Hence NOR gate

50. A *p-n* photodiode is made of a material with a band gap of 2.0 eV. The minimum frequency of the radiation that can be absorbed by the material is nearly

- (1) 20×10^{14} Hz
- (2) 10×10^{14} Hz
- (3) 5×10^{14} Hz
- (4) 1×10^{14} Hz

Sol. Answer (3)

$$\nu = \frac{E}{h} = 5 \times 10^{14} \text{ Hz}$$

51. If uncertainty in position and momentum are equal, then uncertainty in velocity is

- (1) $\sqrt{\frac{h}{\pi}}$
- (2) $\frac{1}{2m} \sqrt{\frac{h}{\pi}}$
- (3) $\sqrt{\frac{h}{2\pi}}$
- (4) $\frac{1}{m} \sqrt{\frac{h}{\pi}}$

$$\Delta x = \Delta p$$

$$\Delta p^2 = \frac{h}{4\pi}$$

$$\text{or } \Delta p = \frac{1}{2} \sqrt{\frac{h}{\pi}}$$

$$\text{or } m\Delta v = \frac{1}{2} \sqrt{\frac{h}{\pi}}$$

$$\text{or } \Delta v = \frac{1}{2m} \sqrt{\frac{h}{\pi}}$$

52. If a gas expands at constant temperature, it indicates that

- (1) Number of the molecules of gas increases (2) Kinetic energy of molecules decreases
 (3) Pressure of the gas increases (4) Kinetic energy of molecules remains the same

Sol. Answer (4)

Kinetic energy of gaseous molecules depends on temperature only.

53. The value of equilibrium constant of the reaction

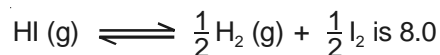

The equilibrium constant of the reaction $\text{H}_2 \text{(g)} + \text{I}_2 \text{(g)} \rightleftharpoons 2\text{HI (g)}$ will be

- (1) $\frac{1}{8}$ (2) $\frac{1}{16}$
 (3) $\frac{1}{64}$ (4) 16

Sol. Answer (3)

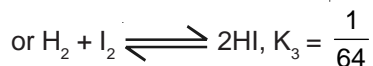
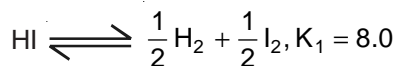

54. If 'a' stands for the edge length of the cubic systems : simple cubic, body centred cubic and face centred cubic, then the ratio of radii of the spheres in these systems will be respectively

- (1) $1a : \sqrt{3}a : \sqrt{2}a$ (2) $\frac{1}{2}a : \frac{\sqrt{3}}{4}a : \frac{1}{2\sqrt{2}}a$
 (3) $\frac{1}{2}a : \sqrt{3}a : \frac{1}{\sqrt{2}}a$ (4) $\frac{1}{2}a : \frac{\sqrt{3}}{2}a : \frac{\sqrt{2}}{2}a$

Sol. Answer (2)
FREE Education

For simple cube, $a = 2r$

$$\text{or } r = \frac{a}{2}$$

For BCC, $4r = \sqrt{3}a$

$$\text{or } r = \frac{\sqrt{3}}{4} a$$

For FCC, $4r = \sqrt{2}a$

$$\text{or } r = \frac{a}{2\sqrt{2}}$$

Thus, the ratio is $\frac{1}{2}a : \frac{\sqrt{3}}{4}a : \frac{1}{2\sqrt{2}}a$

55. Kohlrausch's law states that at

- (1) Infinite dilution, each ion makes definite contribution to equivalent conductance of an electrolyte, whatever be the nature of the other ion of the electrolyte
- (2) Finite dilution, each ion makes definite contribution to equivalent conductance of an electrolyte, whatever be the nature of the other ion of the electrolyte
- (3) Infinite dilution each ion makes definite contribution to equivalent conductance of an electrolyte depending on the nature of the other ion of the electrolyte
- (4) Infinite dilution, each ion makes definite contribution to conductance of an electrolyte whatever be the nature of the other ion of the electrolyte

Sol. Answer (1)

Kohlrausch's law states, "at infinite dilution each ion contributes its fixed value towards equivalent conductance irrespective of the other ion in combination with it at fixed temperature."

56. The measurement of the electron position is associated with an uncertainty in momentum, which is equal to $1 \times 10^{-18} \text{ g cm s}^{-1}$. The uncertainty in electron velocity is, (mass of an electron is $9 \times 10^{-28} \text{ g}$)

- | | |
|--|---------------------------------------|
| (1) $1 \times 10^{11} \text{ cm s}^{-1}$ | (2) $1 \times 10^9 \text{ cm s}^{-1}$ |
| (3) $1 \times 10^6 \text{ cm s}^{-1}$ | (4) $1 \times 10^5 \text{ cm s}^{-1}$ |

Sol. Answer (2)

$$\Delta p = 1 \times 10^{-18} \text{ g cm s}^{-1}$$

$$\text{or } \Delta p = m\Delta v$$

$$\text{or } \Delta v = \frac{\Delta p}{m} = \frac{1 \times 10^{-18}}{9 \times 10^{-28}} \approx 1 \times 10^9 \text{ cm/second}$$

57. Which of the following are not state functions?

- | | |
|--------------------------|-------------------------|
| (I) $q + w$ | (II) q |
| (III) w | (IV) H-TS |
| (1) (II) and (III) | (2) (I) and (IV) |
| (3) (II), (III) and (IV) | (4) (I), (II) and (III) |

$$\Delta U = q + w$$

$$\Delta G = \Delta H - T\Delta S$$

ΔU and ΔG are state functions but q and w are not state functions.

58. The bromination of acetone that occurs in acid solution is represented by this equation

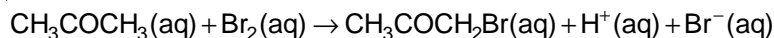

These kinetic data were obtained for given reaction concentrations

Initial concentrations, M		
$[\text{CH}_3\text{COCH}_3]$	$[\text{Br}_2]$	$[\text{H}^+]$
0.30	0.05	0.05
0.30	0.10	0.05
0.30	0.10	0.10
0.40	0.05	0.20

Initial rate, disappearance of Br_2 , M s^{-1}

$$5.7 \times 10^{-5}$$

$$5.7 \times 10^{-5}$$

$$1.2 \times 10^{-4}$$

$$3.1 \times 10^{-4}$$

Based on these data, the rate equation is

(1) Rate = $k[\text{CH}_3\text{COCH}_3][\text{Br}_2][\text{H}^+]$

(2) Rate = $k[\text{CH}_3\text{COCH}_3][\text{H}^+]$

(3) Rate = $k[\text{CH}_3\text{COCH}_3][\text{Br}_2]$

(4) Rate = $k[\text{CH}_3\text{COCH}_3][\text{Br}_2][\text{H}^+]^2$

Sol. Answer (2)

In experiment (1) and (2), rate doesn't depend on the concentration of Br_2 . So, rate expression will not include $[\text{Br}_2]$.

59. What volume of oxygen gas (O_2) measured at 0°C and 1 atm, is needed to burn completely 1 L of propane gas (C_3H_8) measured under the same conditions?

(1) 10 L

(2) 7 L

(3) 6 L

(4) 5 L

Sol. Answer (4)

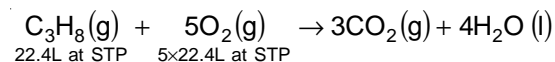

$$\therefore 22.4 \text{ L C}_3\text{H}_8 \text{ at STP} \equiv 5 \times 22.4 \text{ L of O}_2 \text{ at STP}$$

$$\therefore 1 \text{ L C}_3\text{H}_8 \text{ at STP} \equiv \frac{5 \times 22.4}{22.4} \text{ of O}_2 \text{ at STP}$$

$$= 5 \text{ L of O}_2 \text{ at NTP}$$

60. Bond dissociation enthalpy of H_2 , Cl_2 and HCl are 434, 242 and 431 kJmol^{-1} respectively. Enthalpy of formation of HCl is

(1) 245 kJmol^{-1}

(2) 93 kJmol^{-1}

(3) -245 kJmol^{-1}

(4) -93 kJmol^{-1}

Sol. Answer (4)

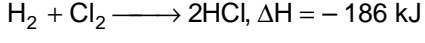
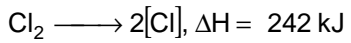
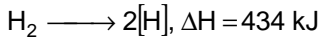
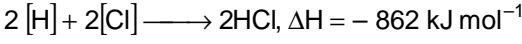

$$\therefore \Delta H_f \text{ of HCl} = \frac{- 186}{2} = - 93 \text{ kJ mol}^{-1}$$

61. Which of the following statements is not correct?

- (1) The number of Bravais lattices in which a crystal can be categorized is 14
- (2) The fraction of the total volume occupied by the atoms in a primitive cell is 0.48
- (3) Molecular solids are generally volatile
- (4) The number of carbon atoms in an unit cell of diamond is 4

Sol. Answer (4)

Diamond has ZnS type structure. So, no. of atoms in a unit cell of diamond is 8.

Note : But option (2) is also incorrect because the fraction of the total volume occupied by the atoms in a cubic primitive cells is 0.524.

62. Equal volumes of three acid solutions of pH 3, 4 and 5 are mixed in a vessel. What will be the H⁺ ion concentration in the mixture?

- (1) $1.11 \times 10^{-3} \text{ M}$
- (2) $1.11 \times 10^{-4} \text{ M}$
- (3) $3.7 \times 10^{-4} \text{ M}$
- (4) $3.7 \times 10^{-3} \text{ M}$

Sol. Answer (3)

$$N_1V_1 + N_2V_2 + N_3V_3 = N_mV_m$$

or $10^{-3} \times 1 + 10^{-4} \times 1 + 10^{-5} \times 1 = N_m \times 3$

or $1.11 \times 10^{-3} = N_m \times 3$

or $N_m = 0.37 \times 10^{-3}$

$[H^+] = 3.7 \times 10^{-4} \text{ M}$

63. The values of K_{p1} and K_{p2} for the reactions

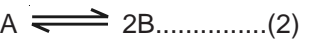
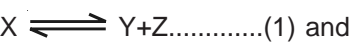

are in ratio of 9:1. If degree of dissociation of X and A be equal, then total pressure at equilibrium (1) and (2) are in the ratio

- (1) 1 : 1
- (2) 3 : 1
- (3) 1 : 9
- (4) 36 : 1

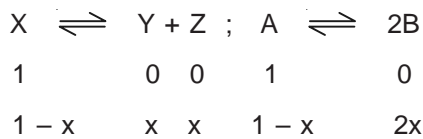

$$\frac{K_{p1}}{K_{p2}} = \frac{\left(\frac{x}{1+x} \times P\right)^2}{\frac{1-x}{1+x} \times P} \cdot \frac{\left(\frac{2x}{1+x} \times P'\right)^2}{\frac{1-x}{1+x} \times P'}$$

$$\text{or } \frac{K_{p1}}{K_{p2}} = \frac{P}{4P'} \quad \text{or } \frac{9}{1} = \frac{P}{4P'}$$

$$\text{or } \frac{P'}{P} = 36 : 1$$

64. If the concentration of OH^- ions in the reaction $\text{Fe}(\text{OH})_3(\text{s}) \rightleftharpoons \text{Fe}^{3+}(\text{aq}) + 3\text{OH}^-(\text{aq})$ is decreased by $\frac{1}{4}$ times, then equilibrium concentration of Fe^{3+} will increase by

- (1) 4 times
- (2) 8 times
- (3) 16 times
- (4) 64 times

Sol. Answer (4)

To maintain the constant value of K_c , the concentration of Fe^{3+} ion will increase by 64 times.

65. For the gas phase reaction, $\text{PCl}_5(\text{g}) \rightleftharpoons \text{PCl}_3(\text{g}) + \text{Cl}_2(\text{g})$ Which of the following conditions is correct?

- (1) $\Delta H > 0$ and $\Delta S < 0$
- (2) $\Delta H = 0$ and $\Delta S < 0$
- (3) $\Delta H > 0$ and $\Delta S > 0$
- (4) $\Delta H < 0$ and $\Delta S < 0$

Sol. Answer (3)

This is an endothermic reaction,

So, $\Delta H > 0$

Since, number of mole in the product side is more

So $\Delta S > 0$.

66. The rate constants k_1 and k_2 for two different reactions are $10^{16} \cdot e^{-2000/T}$ and $10^{15} \cdot e^{-1000/T}$ respectively. The temperature at which $k_1 = k_2$ is

- (1) $\frac{1000}{2.303}$ K
- (2) 1000 K
- (3) $\frac{2000}{2.303}$ K
- (4) 2000 K

Sol. Answer (1)

$$K_1 = 10^{16} e^{-\frac{2000}{T}}$$

or $\log K_1 = 16 - \frac{2000}{2.303T}$

$$K_2 = 10^{15} e^{-\frac{1000}{T}}$$

or $\log K_2 = 15 - \frac{1000}{2.303T}$

If $T = \frac{1000}{2.303} K$, then $K_1 = K_2$

67. Standard free energies of formation (in kJ/mol) at 298 K are -237.2 , -394.4 and -8.2 for $H_2O(l)$, $CO_2(g)$ and pentane (g) respectively. The value of E°_{cell} for the pentane-oxygen fuel cell is
- (1) 0.0968 V (2) 1.968 V
 (3) 2.0968 V (4) 1.0968 V

Sol. Answer (4)

After calculation ΔG° , use the formula, $\Delta G^\circ = -nFE^\circ$

Here, $n = 32$ is taken because balanced equation is

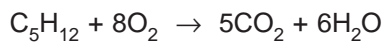

68. The dissociation equilibrium of a gas AB_2 can be represented as, $2AB_2(g) \rightleftharpoons 2AB(g) + B_2(g)$. The degree of dissociation is 'x' and is small compared to 1. The expression relating the degree of dissociation (x) with equilibrium constant K_p and total pressure P is

- (1) $\left(\frac{K_p}{P}\right)$ (2) $\left(\frac{2K_p}{P}\right)$
 (3) $\left(\frac{2K_p}{P}\right)^{1/3}$ (4) $\left(\frac{2K_p}{P}\right)^{1/2}$

Sol. Answer (3)

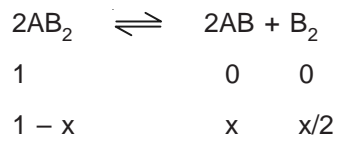

Total mole at equi. = $1 + \frac{x}{2}$

$$\therefore K_p = \frac{\left(\frac{x}{1+x/2} \times P\right)^2 \left(\frac{x/2}{1+x/2} \times P\right)}{\left(\frac{1-x}{1+x/2} \times P\right)^2} \quad \text{(Here x is degree of dissociation)}$$

$$\text{or } K_P = \frac{x^3 P}{2}$$

$$\text{or } x^3 = \frac{2K_P}{P}$$

$$\text{or } x = \left(\frac{2K_P}{P} \right)^{1/3}$$

69. The sequence of ionic mobility in aqueous solution is

(1) $\text{Na}^+ > \text{K}^+ > \text{Rb}^+ > \text{Cs}^+$

(2) $\text{K}^+ > \text{Na}^+ > \text{Rb}^+ > \text{Cs}^+$

(3) $\text{Cs}^+ > \text{Rb}^+ > \text{K}^+ > \text{Na}^+$

(4) $\text{Rb}^+ > \text{K}^+ > \text{Cs}^+ > \text{Na}^+$

Sol. Answer (3)

More the charge density of ion, more will be the ion-dipole interaction, so more will be hydration of ion and hence less will be the ionic mobility.

70. Percentage of free space in a body centred cubic unit cell is

(1) 28%

(2) 30%

(3) 32%

(4) 34%

Sol. Answer (3)

32%

In BCC, packing fraction is 68%.

71. The correct order of decreasing second ionisation enthalpy of Ti (22), V (23), Cr (24) and Mn (25) is

(1) $\text{Ti} > \text{V} > \text{Cr} > \text{Mn}$

(2) $\text{Cr} > \text{Mn} > \text{V} > \text{Ti}$

(3) $\text{V} > \text{Mn} > \text{Cr} > \text{Ti}$

(4) $\text{Mn} > \text{Cr} > \text{Ti} > \text{V}$

Sol. Answer (2)

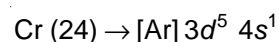

After removing one electron from chromium, the resulting structure becomes more stable. Hence Cr has higher second ionisation enthalpy.

Thus, the correct order is

$$\text{Cr} > \text{Mn} > \text{V} > \text{Ti}$$

72. How many moles of lead (II) chloride will be formed from a reaction between 6.5 g of PbO and 3.2 g of HCl?

(1) 0.029

(2) 0.044

(3) 0.333

(4) 0.011

Sol. Answer (1)

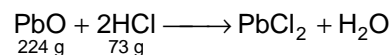

Here, HCl is in excess, hence, PbO is the limiting reactant.

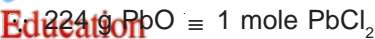

$$\therefore 6.5 \text{ g PbO} = \frac{6.5}{224} \text{ mole PbCl}_2$$

$$= 0.029 \text{ mole}$$

73. Which of the following complexes exhibits the highest paramagnetic behaviour? Where gly = glycine, en = ethylenediamine and bpy = bipyridyl moities). (At. number Ti = 22, V = 23, Fe = 26, Co = 27)

- (1) $[\text{Ti}(\text{NH}_3)_6]^{3+}$ (2) $[\text{V}(\text{gly})_2(\text{OH})_2(\text{NH}_3)_2]^+$
 (3) $[\text{Fe}(\text{en})(\text{bpy})(\text{NH}_3)_2]^{2+}$ (4) $[\text{Co}(\text{OX})_2(\text{OH})_2]^-$

Sol. Answer (4)

74. Volume occupied by one molecule of water (density = 1 g cm^{-3}) is

- (1) $5.5 \times 10^{-23} \text{ cm}^3$ (2) $9.0 \times 10^{-23} \text{ cm}^3$
 (3) $6.023 \times 10^{-23} \text{ cm}^3$ (4) $3.0 \times 10^{-23} \text{ cm}^3$

Sol. Answer (4)

$$\text{Volume of 1 molecule of H}_2\text{O} = \frac{18 \text{ g}}{6.02 \times 10^{23} \times 1 \text{ g/cc}}$$

$$\cong 3.0 \times 10^{-23} \text{ cm}^3$$

75. Number of moles of MnO_4^- required to oxidize one mole of ferrous oxalate completely in acidic medium will be

- (1) 0.2 moles (2) 0.6 moles
 (3) 0.4 moles (4) 7.5 moles

Sol. Answer (2)

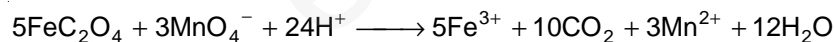
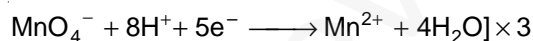
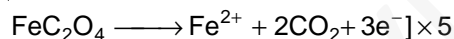

$$5 \text{ mol FeC}_2\text{O}_4 \equiv 3 \text{ mol MnO}_4^-$$

$$\therefore 1 \text{ mol FeC}_2\text{O}_4 \equiv \frac{3}{5} \text{ mol MnO}_4^-$$

$$= 0.6 \text{ mol MnO}_4^-$$

76. On the basis of the following E° values, the strongest oxidizing agent is

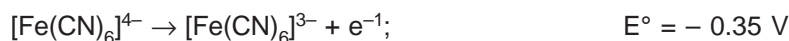

- (1) $[\text{Fe}(\text{CN})_6]^{3-}$ (2) $[\text{Fe}(\text{CN})_6]^{4-}$
 (3) Fe^{2+} (4) Fe^{3+}

Sol. Answer (4)

Higher the reduction potential higher will be the oxidising power.

77. The alkali metals from salt-like hydrides by the direct synthesis at elevated temperature. The thermal stability of these hydrides decreases in which of the following orders?

- | | |
|---|---|
| (1) $\text{LiH} > \text{NaH} > \text{KH} > \text{RbH} > \text{CsH}$ | (2) $\text{CsH} > \text{RbH} > \text{KH} > \text{NaH} > \text{LiH}$ |
| (3) $\text{KH} > \text{NaH} > \text{LiH} > \text{CsH} > \text{RbH}$ | (4) $\text{NaH} > \text{LiH} > \text{KH} > \text{RbH} > \text{CsH}$ |

Sol. Answer (1)

Thermal stability of ionic hydrides decreases down the group due to increase in difference in size.

78. Which one of the following arrangements does not give the correct picture of the trends indicated against it?

- | | |
|---|--------------------------|
| (1) $\text{F}_2 > \text{Cl}_2 > \text{Br}_2 > \text{I}_2$: | Electronegativity |
| (2) $\text{F}_2 > \text{Cl}_2 > \text{Br}_2 > \text{I}_2$: | Oxidizing power |
| (3) $\text{F}_2 > \text{Cl}_2 > \text{Br}_2 > \text{I}_2$: | Electron gain enthalpy |
| (4) $\text{F}_2 > \text{Cl}_2 > \text{Br}_2 > \text{I}_2$: | Bond dissociation energy |

Sol. Answer (4)

Due to high electron density on F the bond dissociation energy of F_2 is lower and the correct order is

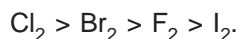

Note : Electron gain enthalpy is concerned with atoms and not the molecules.

79. With which one of the following elements silicon should be doped so as to give p-type of semiconductor?

- | | |
|-------------|---------------|
| (1) Boron | (2) Germanium |
| (3) Arsenic | (4) Selenium |

Sol. Answer (1)

Doping of group 14 elements with elements of group 13 gives p-type semiconductor due to generation of holes.

80. In which of the following coordination entities the magnitude of ΔO (CFSE in octahedral field) will be maximum (at. no. Co = 27)?

- | | |
|--|--|
| (1) $[\text{Co}(\text{C}_2\text{O}_4)_3]^{3-}$ | (2) $[\text{Co}(\text{H}_2\text{O})_6]^{3+}$ |
| (3) $[\text{Co}(\text{NH}_3)_6]^{3+}$ | (4) $[\text{Co}(\text{CN})_6]^{3-}$ |

Sol. Answer (4)

CN^- is very strong field ligand.

81. The angular shape of molecule (O_3) consists of

- | | |
|----------------------------|----------------------------|
| (1) 2 sigma and 1 pi bond | (2) 1 sigma and 2 pi bonds |
| (3) 2 sigma and 2 pi bonds | (4) 1 sigma and 1 pi bond |

Sol. Answer (1)

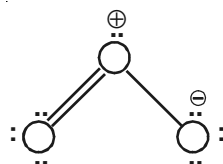

FREE Education

82. The correct order of increasing bond angles in the following triatomic species is

- (1) $\text{NO}_2^+ < \text{NO}_2^- < \text{NO}_2$ (2) $\text{NO}_2^- < \text{NO}_2^+ < \text{NO}_2$
 (3) $\text{NO}_2^- < \text{NO}_2 < \text{NO}_2^+$ (4) $\text{NO}_2^+ < \text{NO}_2 < \text{NO}_2^-$

Sol. Answer (3)

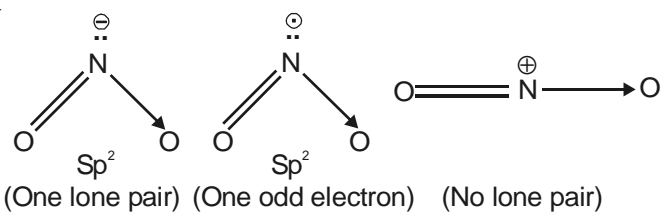

83. Four diatomic species are listed below the different sequences. Which of these presents the correct order of their increasing bond order?

- (1) $\text{He}_2^+ < \text{O}_2^- < \text{NO} < \text{C}_2^{2-}$ (2) $\text{O}_2^- < \text{NO} < \text{C}_2^{2-} < \text{He}_2^+$
 (3) $\text{NO} < \text{C}_2^{2-} < \text{O}_2^- < \text{He}_2^+$ (4) $\text{C}_2^{2-} < \text{He}_2^+ < \text{NO} < \text{O}_2^-$

Sol. Answer (1)

Bond orders of different species are

- $\text{He}_2^+ - 0.5$
 $\text{O}_2^- - 1.5$
 $\text{NO} - 2.5$
 $\text{C}_2^{2-} - 3.0$

84. Equimolar solutions of the following were prepared in water separately. Which one of the solutions will record the highest pH?

- (1) CaCl_2 (2) SrCl_2
 (3) BaCl_2 (4) MgCl_2

Sol. Answer (3)

pH increases with increase in basicity of aqueous solution. Basicity of halides of s-block in aqueous solution increases down the group.

85. In the hydrocarbon

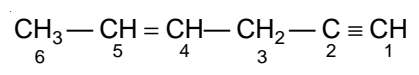

The state of hybridization of carbons 1, 3 and 5 are in the following sequence

- (1) sp^3, sp^2, sp (2) sp^2, sp, sp^3
 (3) sp, sp^3, sp^2 (4) sp, sp^2, sp^3

Sol. Answer (3)

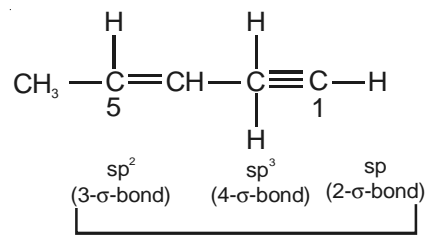

86. Green chemistry means such reactions which

- (1) Study the reactions in plants
- (2) Produce colour during reactions
- (3) Reduce the use and production of hazardous chemicals
- (4) Are related to the depletion of ozone layer

Sol. Answer (3)

Factual

87. A strong base can abstract an α -hydrogen from

- | | |
|------------|------------|
| (1) Alkane | (2) Alkene |
| (3) Amine | (4) Ketone |

Sol. Answer (4)

α -hydrogen in ketone is very acidic since its removal gives resonance stabilised carbanions.

88. How many stereoisomers does the molecule have?



- | | |
|-------|-------|
| (1) 2 | (2) 4 |
| (3) 6 | (4) 8 |

Sol. Answer (2)

There is one geometrical and one chiral centre in the molecule. Thus isomers will be

- (1) Cis-d form
- (2) Trans-d form
- (3) Cis-l form
- (4) Trans-l form

89. The stability of carbanions in the following

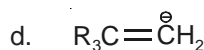
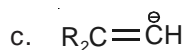
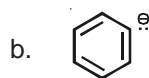

is in the order of

- | | |
|---------------------|---------------------|
| (1) $a > c > b > d$ | (2) $a > b > c > d$ |
| (3) $b > c > d > a$ | (4) $d > b > c > a$ |

Sol. Answer (2)

Higher is the electronegativity of atom higher will be stability of carbanion on it. Higher is the s-character, higher will be the electronegativity of atom.

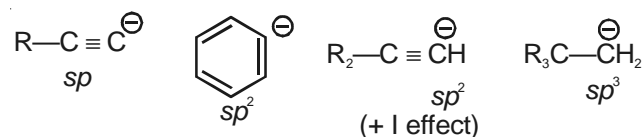

FREE Education

90. The relative reactivities of acyl compounds towards nucleophilic substitution are in the order of

- (1) Acyl chloride > Ester > Acid anhydride > Amide
- (2) Acyl chloride > Acid anhydride > Ester > Amide
- (3) Ester > Acyl chloride > Amide > Acid anhydride
- (4) Acid anhydride > Amide > Ester > Acyl chloride

Sol. Answer (2)

Better is the leaving group higher will be the reactivity of acyl compounds towards nucleophilic acyl substitution. Weaker is the base, better is the leaving group. Weaker bases are derived from stronger acids.

91. Base strength of

- a. $\text{H}_3\text{C}\overset{\ominus}{\text{C}}\text{H}_2$
- b. $\text{H}_2\text{C}=\overset{\ominus}{\text{C}}\text{H}$
- c. $\text{H}-\text{C}=\overset{\ominus}{\text{C}}$

is in the order of

- (1) $a > b > c$
- (2) $b > a > c$
- (3) $c > b > a$
- (4) $a > c > b$

Sol. Answer (1)

Stronger is the conjugate acid weaker will be corresponding conjugate base. Acidity of conjugate acids of given carbanions is $\text{c} < \text{b} < \text{a}$

Thus order of basicity of given carbanions will be $\text{a} > \text{b} > \text{c}$

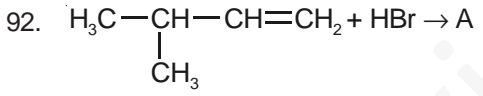

A (predominantly) is

- (1) $\text{CH}_3-\underset{\text{CH}_3}{\text{CH}}-\underset{\text{Br}}{\text{CH}}-\text{CH}_3$
- (2) $\text{CH}_3-\underset{\text{CH}_3}{\text{CH}}-\text{CH}_2-\text{CH}_2\text{Br}$
- (3) $\text{CH}_3-\overset{\text{Br}}{\text{C}}-\text{CH}_2\text{CH}_3$
- (4) $\text{CH}_3-\underset{\text{Br}}{\text{CH}}-\underset{\text{CH}_3}{\text{CH}}-\text{CH}_3$

Sol. Answer (3)

Reaction is electrophilic addition which proceeds through carbocation reaction intermediate which undergo hydride shift.

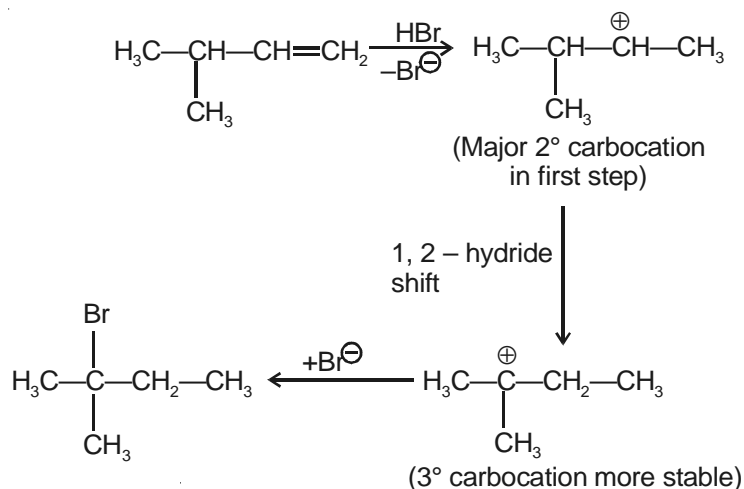

93. In DNA, the complimentary bases are
- (1) Uracil and adenine; cytosine and guanine
 - (2) Adenine and thymine; guanine and cytosine
 - (3) Adenine and thymine; guanine and uracil
 - (4) Adenine and guanine; thymine and cytosine

Sol. Answer (2)

A === T

G === C

94. Which one the following is most reactive towards electrophilic attack?

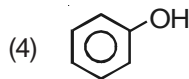
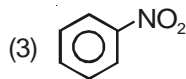
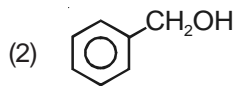
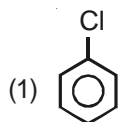

Sol. Answer (4)

Hydroxy group is most activating group among given options, towards electrophilic attack.

95. An organic compound contains carbon, hydrogen and oxygen. Its elemental analysis gave C, 38.71% and H, 9.67%. The empirical formula of the compound would be
- (1) CH₄O
 - (2) CH₃O
 - (3) CH₂O
 - (4) CHO

Sol. Answer (2)

Element	Percentage	Molar ratio	Simple molar ratio
C	38.71	3.22	1
H	9.67	9.67	3
O	51.62	3.22	1

96. In an S_N2 substitution reaction of the type



Which one of the following has the highest relative rate?

- (1) CH_3CH_2Br
- (2) $CH_3-CH_2-CH_2Br$
- (3) $CH_3-\underset{\substack{| \\ CH_3}}{CH}-CH_2Br$
- (4) $CH_3-\underset{\substack{| \\ CH_3}}{\overset{\substack{| \\ CH_3}}{C}}-CH_2Br$

Sol. Answer (1)

For S_N2 reaction, there should be low steric hindrance for better reactivity.

97. Acetophenone when reacted with a base, C_2H_5ONa , yields a stable compound which has the structure?

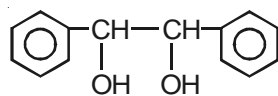
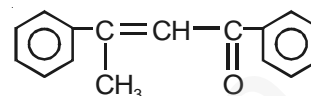
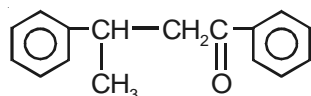
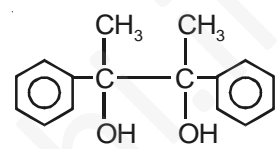
- (1) 
- (2) 
- (3) 
- (4) 

Sol. Answer (2)

It shows condensation reaction

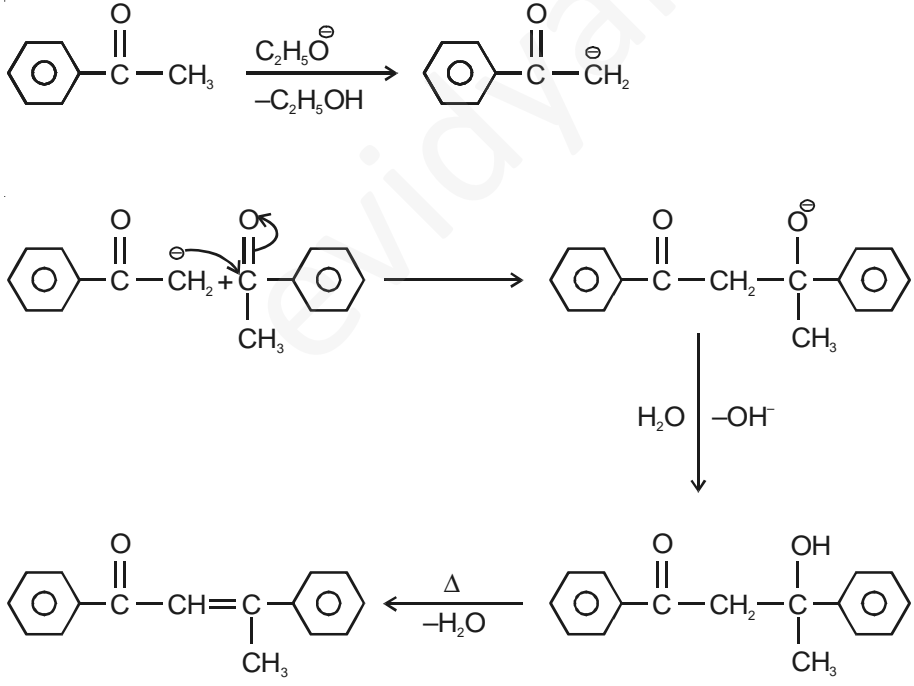

98. In a reaction of aniline a coloured product C was obtained.

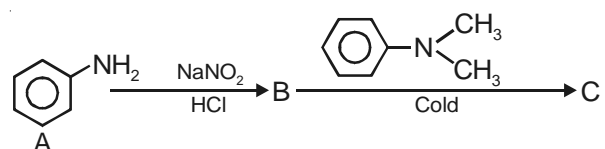

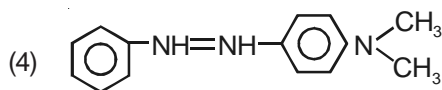
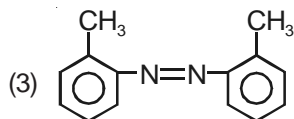
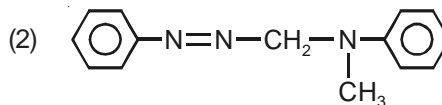
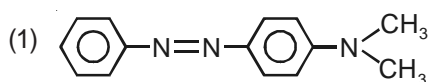

Sol. Answer (1)

Diazotisation followed electrophilic substitution at para position.

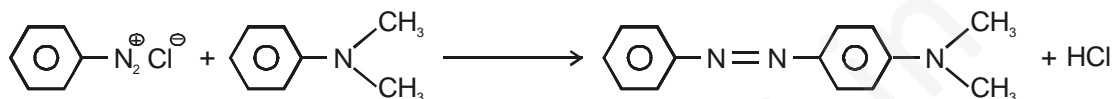
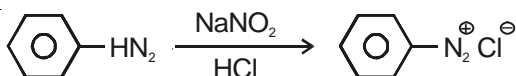

99. Which of the following statements is not true?

- (1) Natural rubber is a 1, 4 - polymer of isoprene
- (2) In vulcanization, the formation of sulphur bridges between different chains make rubber harder and stronger
- (3) Natural rubber has the trans-configuration at every double bond
- (4) Buna-S is a copolymer of butadiene and styrene

Sol. Answer (3)

Natural rubber has cis-configuration at each double bond.

Gutta-Percha has trans-configuration of each double bond.

100. Which one of the following is an amine hormone?

- | | |
|------------------|---------------|
| (1) Progesterone | (2) Thyroxine |
| (3) Oxyurin | (4) Insulin |

Sol. Answer (2)

Thyroxine-derived from tyrosine amino acid.

Insulin - Polypeptide.

Progesterone - Steroid hormone.

101. Select one of the following of important features distinguishing *Gnetum* from *Cycas* and *Pinus* and showing affinities with angiosperms

- (1) Embryo development and apical meristem
- (2) Absence of resin duct and leaf venation
- (3) Presence of vessel elements and absence of archegonia
- (4) Perianth and two integuments

Sol. Answer (3)

Members of order Gnetales possess vessels and show absence of archegonia.

FREE Education

102. *Thermococcus*, *Methanococcus* and *Methanobacterium* exemplify

- (1) Bacteria that contain a cytoskeleton and ribosomes
- (2) Archaeobacteria that contain protein homologous to eukaryotic core histones
- (3) Archaeobacteria that lack any histones resembling those found in eukaryotes but whose DNA is negatively supercoiled
- (4) Bacteria whose DNA is relaxed or positively supercoiled but which have a cytoskeleton as well as mitochondria

Sol. Answer (3)

Archaeobacteria have –ve supercoiled DNA but histones are chemically different in composition from eukaryotes.

103. Which one of the following is heterosporous?

- (1) *Equisetum*
- (2) *Dryopteris*
- (3) *Salvinia*
- (4) *Adiantum*

Sol. Answer (3)

Others are homosporous pteridophytes.

104. In which one of the following male and female gametophytes do not have free living independent existence?

- (1) *Cedrus*
- (2) *Pteris*
- (3) *Funaria*
- (4) *Polytrichum*

Sol. Answer (1)

Cedrus is gymnosperm having reduced dependent gametophytes as pollen and endosperm.

105. Which one of the following groups of three animals each is **correctly** matched with their one characteristic morphological feature?

Animals	Morphological feature
(1) Cockroach, Locust, <i>Taenia</i>	- Metameric segmentation
(2) Liver fluke, Sea anemone, Sea cucumber	- Bilateral symmetry
(3) Centipede, Prawn, Sea urchin	- Jointed appendages
(4) Scorpion, Spider, Cockroach	- Ventral solid central nervous system

Sol. Answer (4)

106. Which one of the following phyla is correctly matched with its two general characteristics?

- (1) Mollusca - Normally oviparous and development through a trochophore or veliger larva
- (2) Arthropoda - Body divided into head, thorax and abdomen and respiration by tracheae
- (3) Chordata - Notochord at some stage and separate anal and urinary openings to the outside
- (4) Echinodermata - Pentamerous radial symmetry and mostly internal fertilization

Sol. Answer (1)

107. Which one of the following in birds, indicates their reptilian ancestry?

- (1) Eggs with a calcareous shell
- (2) Scales on their hind limbs
- (3) Four-chambered heart
- (4) Two special chambers crop and gizzard in their digestive tract

Sol. Answer (2)

108. *Ascaris* is characterized by

- (1) Presence of true coelom and metamerism (metamerisation)
- (2) Absence of true coelom but presence of metamerism
- (3) Presence of neither true coelom nor metamerism
- (4) Presence of true coelom but absence of metamerism

Sol. Answer (3)

109. Which one of the following is **not** a characteristic of phylum Annelida?

- (1) Ventral nerve cord
- (2) Closed circulatory system
- (3) Segmentation
- (4) Pseudocoelom

Sol. Answer (4)

110. Cellulose is the major component of cell walls of

- (1) *Saccharomyces*
- (2) *Pythium*
- (3) *Xanthomonas*
- (4) *Pseudomonas*

Sol. Answer (2)

Pythium is a phycomyces member having cellulosic cell wall.
Xanthomonas and *Pseudomonas* are Eubacteria having peptidoglycan cell wall. *Saccharomyces* – Chitinous cell wall.

111. Vacuole in a plant cell

- (1) Lacks membrane and contains water and excretory substances
- (2) Is membrane-bound and contains storage proteins and lipids
- (3) Is membrane-bound and contains water and excretory substances
- (4) Lacks membrane and contains air

Sol. Answer (3)

It is having tonoplast as membrane and stores water and excretory substances.

112. A competitive inhibitor of succinic dehydrogenase is

- (1) Malate
- (2) Malonate
- (3) Oxaloacetate
- (4) α -ketoglutarate

Sol. Answer (2)

Malonate competes with succinate for active sites of succinate dehydrogenase.

113. Polysome is formed by

- (1) Ribosomes attached to each other in a linear arrangement
- (2) Several ribosomes attached to a single mRNA
- (3) Many ribosomes attached to a strand of endoplasmic reticulum
- (4) A ribosome with several subunits

Sol. Answer (2)

This structure appears during protein synthesis in cytoplasm to translate different parts of a polypeptide.

114. Carbohydrates are commonly found as starch in plant storage organs. Which of the following five properties of starch (a - e) make it useful as a storage material?

- a. Easily translocated
- b. Chemical non-reactive
- c. Easily digested by animals
- d. Osmotically inactive
- e. Synthesized during photosynthesis

The useful properties are

- (1) Both a & e
- (2) Both b & c
- (3) Both b & d
- (4) a, c & e

Sol. Answer (3)

Starch is nonreducing and water insoluble so is preferred as storage material.

115. In the light of recent classification of living organisms into three domains of life (bacteria, archaea and eukarya), which one of the following statements is true about archaea?

- (1) Archaea completely differ from prokaryotes
- (2) Archaea resemble eukarya in all respects
- (3) Archaea have some novel features that are absent in other prokaryotes and eukaryotes
- (4) Archaea completely differ from both prokaryotes and eukaryotes

Sol. Answer (3)

Archaea have primitive forms with histones, no organized nucleus, membrane bound organelles absent and proteinous and noncellulosic carbohydrate nature of cell wall.

116. Keeping in view the 'fluid mosaic model' for the structure of cell membrane, which one of the following statements is **correct** w.r.t. the movement of lipids and proteins from one lipid monolayer to the other (described as flip-flop movement)?

- (1) Neither lipids nor proteins can flip-flop
- (2) Both lipids and proteins can flip-flop
- (3) While lipids can rarely flip-flop, proteins cannot
- (4) While proteins can flip-flop, lipids cannot

Sol. Answer (3)

It is exclusive property of lipids shown during changing temperature of cellular environment.

117. In germinating seeds fatty acids are degraded exclusively in the

- (1) Mitochondria
- (2) Proplastids
- (3) Glyoxysomes
- (4) Peroxisomes

Sol. Answer (3)

It is regulated by glyoxylate cycle.

118. The two sub-units of ribosome remain united at a critical ion level of

- (1) Calcium
- (2) Copper
- (3) Manganese
- (4) Magnesium

Sol. Answer (4)

Mangesium concentration is 0.0001 M.

119. Thorn of *Bougainvillea* and tendril of *cucurbita* are example of

- (1) Retrogressive evolution
- (2) Analogous organs
- (3) Homologous organs
- (4) Vestigial organs

Sol. Answer (3)

120. Haploids are more suitable for mutation studies than the diploids. This is because

- (1) All mutations, whether dominant or recessive are expressed in haploids
- (2) Haploids are reproductively more stable than diploids
- (3) Mutagens penetrate in haploids more effectively than diploids
- (4) Haploids are more abundant in nature than diploids

Sol. Answer (1)

Haploids have only one set of chromosome hence alleles.

121. Which one of the following pairs of nitrogenous bases of nucleic acids, is wrongly matched with the category mentioned against it?

- (1) Adenine, Thymine – *Purines*
- (2) Thymine, Uracil – *Pyrimidines*
- (3) Uracil, Cytosine – *Pyrimidines*
- (4) Guanine, Adenine – *Purines*

Sol. Answer (1)

Adenine and guanine are purines, whereas, Uracil, Thymine, Cytosine are pyrimidines.

122. Which one of the following conditions in humans is correctly matched with its chromosomal abnormality/linkage?

- (1) Down syndrome – 44 autosomes + XO
- (2) Klinefelter syndrome – 44 autosomes + XXY
- (3) Colour blindness – Y-linked
- (4) Erythroblastosis foetalis – X-linked

Sol. Answer (2)

Downs syndrome – 45 + XX or 45 + XY

123. In the DNA molecules

- (1) There are two strands which run antiparallel-one in 5' → 3' direction and other in 3' → 5'
- (2) The total amount of purine nucleotides and pyrimidine nucleotides is not always equal
- (3) There are two strands which run parallel in the 5' → 3' direction
- (4) The proportion of Adenine in relation to thymine varies with the organism

Sol. Answer (1)

The 2 strands of DNA are antiparallel one in 5' – 3' direction and the other in 3' – 5' direction.

124. What is true about the isolated small tribal populations?

- (1) There is no change in population size as they have a large gene pool
- (2) There is a decline in population as boys marry girls only from their own tribe
- (3) Hereditary diseases like colour blindness do not spread in the isolated population
- (4) Wrestlers who develop strong body muscles in their life time pass this character on to their progeny

FREE Education
Sol. Answer (2)

The acquired character such as strong muscles of a wrestler obtained by regular exercise will not be transmitted to the next generation. Gene pool of a population will consist of a large number of genes which will vary in their frequencies. These frequencies also depend on proportion of various genotypes in the total population. Small tribal population will have small gene pool.

Hereditary diseases like colour blindness will spread in isolated population due to inbreeding.

There is a decline in population as boys marry girls only from their own tribe, this is due to absence of gene migration/gene flow.

125. Which one of the following scientist's name is correctly matched with the theory put forth by him?

- (1) Mendel – Theory of Pangenesis
- (2) Weismann – Theory of continuity of Germplasm
- (3) Pasteur – Inheritance of acquired characters
- (4) de Vries – Natural selection

Sol. Answer (2)

Following are the right matching pairs.

- de Vries - Mutation theory
- Darwin - Theory of pangenesis and Natural selection
- Pasteur - Discarded the theory of spontaneous generation of life and proved that life arises from pre-existing life.

126. Which one of the following is incorrect about the characteristics of protobionts (coacervates and micropheres) as envisaged in the abiogenic origin of life?

- (1) They could maintain an internal environment
- (2) They were able to reproduce
- (3) They could separate combinations of molecules from the surroundings
- (4) They were partially isolated from the surroundings

Sol. Answer (2)

According to recent literature, coacervates and microsphere do not reproduce.

127. Darwin's Finches are an excellent example of

- (1) Connecting links
- (2) Adaptive radiation
- (3) Seasonal migration
- (4) Brood parasitism

Sol. Answer (2)

Darwin's Finches are examples of evolutionary divergence giving rise to new species, arising from one common ancestor, depending upon the habitat.

128. Which one of the following pairs of items correctly belongs to the category of organs mentioned against it?

- (1) Wings of honey-bee and wings of crow – Homologous organs
- (2) Thorn of *Bougainvillea* and tendrils of *Cucurbita* – Analogous organs
- (3) Nictitating membrane and blind spot in human eye – Vestigial organs
- (4) Nephridia of earthworm and malpighian tubules of cockroach – Excretory organs

Sol. Answer (4)

Wings of honey bee and the wings of crow are analogous.

Thorn of **Bougavillea** and tendrils of Cucurbita are homologous.

Blind spot in humans represent the point where the optic nerve will leave the eye ball so it is not vestigeal.

129. The fruit is chambered, developed from inferior ovary and has seeds with succulent testa in

- (1) Cucumber
- (2) Pomegranate
- (3) Orange
- (4) Guava

Sol. Answer (2)

This forms edible part of pomegranate.

130. The C_4 plants are phoptosynthetically more efficient than C_3 plants because

- (1) They have more chloroplasts
- (2) The CO_2 compensation point is more
- (3) CO_2 generated during photorespiration is trapped and recycled through PEP carboxylase
- (4) The CO_2 efflux is not prevented

Sol. Answer (1)

C_4 plants do not show photorespiration and have more chloroplast in bundle sheath.

131. The chemiosmotic coupling hypothesis of oxidative phosphorylation proposes that adenosine triphosphate (ATP) is formed because

- (1) There is a change in the permeability of the inner mitochondrial membrane toward adenosine diphosphate (ADP)
- (2) High energy bonds are formed in mitochondrial proteins
- (3) ADP is pumped out of the matrix into the intermembrane space
- (4) A proton gradient forms across the inner membrane

Sol. Answer (4)

Proton motive force develop between perimitochondrial space and matrix across inner mitochondrial membrane.

132. Dry indehiscent single-seeded fruit formed bicarpellary syncarpous inferior ovary is

- (1) Cremocarp
- (2) Caryopsis
- (3) Cypsela
- (4) Berry

Sol. Answer (3)

Cypsela — Asteraceae.

Cremocarp — Shizocarpic fruit, as in umbelliferae.

Caryopsis — Indehiscent fruit formed from monocarpellary and superior ovary with basal placentation.

133. The rupture and fractionation do not usually occur in the water column in vessel/tracheids during the ascent of sap because of

- (1) Transpiration pull
- (2) Lignified thick walls
- (3) Cohesion and adhesion
- (4) Weak gravitational pull

Sol. Answer (3)

Continuity of water column is maintained by cohesion and adhesion.

134. Senescence as an active developmental cellular process in the growth and functioning of a flowering plant, is indicated in

- (1) Floral parts
- (2) Vessels and tracheid differentiation
- (3) Leaf abscission
- (4) Annual plants

Sol. Answer (3)

Abscission provides nutrient movement and rejuvenation of plant.

135. Vascular tissues in flowering plants develop from

- (1) Dermatogen
- (2) Phellogen
- (3) Plerome
- (4) Periblem

Sol. Answer (3)

Periblem — Ground tissue

Phellogen — Cork cambium

Dermatogen — Epidermis

136. In leaves of C_4 plants malic acid synthesis during CO_2 fixation occurs in

- (1) Guard cells
- (2) Epidermal cells
- (3) Mesophyll cells
- (4) Bundle sheath

Sol. Answer (3)

Bundle sheath malic acid is transported from mesophylls.

137. Importance of day length in flowering of plants was first shown in

- (1) *Petunia*
- (2) *Lemna*
- (3) Tobacco
- (4) Cotton

Sol. Answer (3)

Discovered by Garner & Allard in a maryland mammoth variety of tobacco.

138. Endosperm is consumed by developing embryo in the seed of

- (1) Maize
- (2) Coconut
- (3) Castor
- (4) Pea

Sol. Answer (4)

Other three are endospermic/albuminous seeds.

139. Nitrogen fixation in root nodules of *Alnus* is brought about by

- (1) *Azorhizobium*
- (2) *Bradyhizobium*
- (3) *Clostridium*
- (4) *Frankia*

Sol. Answer (4)

Frankia is actinomycete.

Bradyrhizobium — Root nodules in soyabean.

140. The energy releasing process in which the substrate is oxidised without an external electron acceptor is called

- | | |
|----------------------|-------------------------|
| (1) Glycolysis | (2) Fermentation |
| (3) Photorespiration | (4) Aerobic respiration |

Sol. Answer (2)

Fermentation consumes NADH_2 and e^- acceptor is released as NAD^+ not used. While glycolysis uses external e^- acceptor as NAD^+ .

141. Replum is present in the ovary of flower of

- | | |
|-------------|---------------|
| (1) Pea | (2) Lemon |
| (3) Mustard | (4) Sunflower |

Sol. Answer (3)

Mustard (Brassicaceae) possess false septum in ovary having parietal placentation.

142. The fleshy receptacle of syconus of fig encloses a number of

- | | |
|---------------|-------------|
| (1) Mericarps | (2) Achenes |
| (3) Samaras | (4) Berries |

Sol. Answer (2)

Syconus is fruit type in fig which is composed of many acheneal fruitlets.

143. Electrons from excited chlorophyll molecule of photosystem II are accepted first by

- | | |
|--------------------|--------------------|
| (1) Ferredoxin | (2) Cytochrome - b |
| (3) Cytochrome - f | (4) Quinone |

Sol. Answer (4)

Plastoquinone is used as mobile carrier and primary electron acceptor from PS II.

144. Which type of white blood cells are concerned with the release of histamine and the natural anticoagulant heparin?

- | | |
|---------------|-----------------|
| (1) Monocytes | (2) Neutrophils |
| (3) Basophils | (4) Eosinophils |

Sol. Answer (3)

Basophils have a function similar to mast cells. So both basophils and mast cells contain *heparin*, *histamine* and serotonin.

145. Which one of the following is the true description about an animal concerned?

- | | | |
|---------------|---|--|
| (1) Cockroach | – | 10 pairs of spiracles (2 pairs on thorax and 8 pairs on abdomen) |
| (2) Earthworm | – | The alimentary canal consists of a sequence of pharynx, oesophagus, stomach, gizzard and intestine |
| (3) Frog | – | Body divisible into three regions - head, neck and trunk |
| (4) Rat | – | Left kidney is slightly higher in position than the right one |

Sol. Answer (1)

In rat right kidney is slightly higher than left because all the organs are concentrated towards left, only in human beings left kidney is higher. In earthworm the correct sequence of alimentary canal is pharynx, oesophagus, gizzard, stomach and intestine. In Frog, neck is absent.

146. Which one of the following is the correct matching of the site of action on the given substrate, the enzyme acting upon it and the end product?

- (1) *Stomach* : Fats $\xrightarrow{\text{Lipase}}$ micelles
- (2) *Duodenum* : Triglycerides $\xrightarrow{\text{Trypsin}}$ monoglycerides
- (3) *Small intestine* : Starch $\xrightarrow{\alpha\text{-Amylase}}$ Disaccharide (Maltose)
- (4) *Small intestine* : Proteins $\xrightarrow{\text{Pepsin}}$ Amino acids

Sol. Answer (3)

Pancreatic juice is released in intestine & contains, Pancreatic α -amylase, also called as Amylopsin, it digests 70% of the starch converting it into Maltose, Isomaltose and limit dextrans.

147. What is vital capacity of our lungs?

- (1) Total lungs capacity minus residual volume
- (2) Inspiratory reserve volume plus tidal volume
- (3) Total lungs capacity minus expiratory reserve volume
- (4) Inspiratory reserve volume plus expiratory reserve volume

Sol. Answer (1)

Vital capacity = TV + IRV + ERV

Total lung capacity = VC + RV

So we can say that VC = Total lung capacity – Residual volume.

148. Which one of the following is the correct difference between *Rod Cells* and *Cone Cells* of our retina?

	Rod Cells	Cone Cells
(1) Distribution	More concentrated in centre of retina	Evenly distributed all over retina
(2) Visual acuity	High	Low
(3) Visual pigment contained	Iodopsin	Rhodopsin
(4) Overall function	Vision in poor light	Colour vision and detailed vision in bright light

Sol. Answer (4)

Rod cells are more concentrated towards the periphery. Visual **acuity** is highest in fovea centralis which contains only cones. Visual pigment in rods cells is rhodopsin, whereas in the cone cells it is **iodopsin**.

149. Which one of the following items gives its correct total number?

- (1) Cervical vertebrae in humans – 8
- (2) Floating ribs in humans – 4
- (3) Amino acids found in proteins – 16
- (4) Types of diabetes – 3

Sol. Answer (2)

In human beings floatings ribs are 2 pairs (4), i.e. 11th and 12th ribs.

150. Given below is a diagrammatic cross section of a single loop of human cochlea

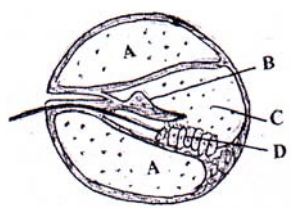

Which one of the following options correctly represents the names of three different parts?

- (1) A : Perilymph, B : Tectorial membrane, C : Endolymph
- (2) B : Tectorial membrane, C : Perilymph, D : Secretory cells
- (3) C : Endolymph, D : Sensory hair cells, A : Serum
- (4) D : Sensory hair cells, A : Endolymph, B : Tectorial membrane

Sol. Answer (1)

In the diagram of human cochlea.

- A. represents - Perilymph
- B. represents - Tectorial membrane
- C. represents - Endolymph
- D. represents - Sensory cells

151. Given below are four methods (A - D) and their modes of action (a - d) in achieving contraception. Select their correct matching from the four options that follow

Method	Mode of Action
A. The pill	(a) Prevents sperms reaching cervix
B. Condom	(b) Prevents implantation
C. Vasectomy	(c) Prevents ovulation
D. Copper T	(d) Semen contains no sperms

Matching

- (1) A-(b), B-(c), C-(a), D-(d)
- (2) A-(c), B-(a), C-(d), D-(b)
- (3) A-(d), B-(a), C-(b), D-(c)
- (4) A-(c) B-(d), C-(a), D-(b)

Sol. Answer (2)

Oral contraceptive pills contain estrogen and progesterone hormones, so they alter the ovulatory cycle and mainly prevent ovulation. Condoms are physical barrier, they prevent the sperms reaching cervix. Vasectomy is the surgical and terminal method of birth control in males. They do not prevent sperm production, but hinder sperm transport so the semen will not contain any sperms. IUDs e.g. Copper-T prevent fertilization and mainly **implantation**.

152. What will happen if the secretion of parietal cells of gastric glands is blocked with an inhibitor?

- (1) Enterokinase will not be released from the duodenal mucosa and so trypsinogen is not converted to trypsin
- (2) Gastric juice will be deficient in chymosin
- (3) Gastric juice will be deficient in pepsinogen
- (4) In the absence of HCl secretion, inactive pepsinogen is not converted into the active enzyme pepsin.

Sol. Answer (4)

Parietal cells/oxyntic cells, their function is to secrete HCl and **Castle's intrinsic factor**. Pepsinogen, is converted into active pepsin by HCl, i.e. by change in pH.

153. During the propagation of a nerve impulse, the action potential results from the movement of

- (1) Na^+ ions from extracellular fluid to intracellular fluid
- (2) K^+ ions from extracellular fluid to intracellular fluid
- (3) Na^+ ions from intracellular fluid to extracellular fluid
- (4) K^+ ions from intracellular fluid to extracellular fluid

Sol. Answer (1)

When the threshold stimulus is applied, the permeability of the membrane for sodium ions will change. Voltage gated sodium ion channels open and Na^+ ion flows from extra-cellular fluid to intracellular fluid, the outside becomes negative and inside positive. The membrane is depolarised & when the two ends of this membrane is connected to oscilloscope a potential difference of + 30 mv, called as action potential is generated.

154. The blood calcium level is lowered by the deficiency of

- (1) Calcitonin
- (2) Parathormone
- (3) Thyroxine
- (4) Both Calcitonin and Parathormone

Sol. Answer (2)

155. The most active phagocytic white blood cells are

- (1) Neutrophils and monocytes
- (2) Neutrophils and eosinophils
- (3) Lymphocytes and macrophages
- (4) Eosinophils and lymphocytes

Sol. Answer (1)

Neutrophils and monocytes have phagocytic function.

156. Earthworms have no skeleton but during burrowing, the anterior end becomes turgid and acts as a hydraulic skeleton. It is due to

- | | |
|-----------|---------------------|
| (1) Setae | (2) Coelomic fluid |
| (3) Blood | (4) Gut peristalsis |

Sol. Answer (2)

Setae help in attachment, but turgidity and hydraulic skeleton is due to coelomic fluid.

157. In humans, blood passes from the post caval to the diastolic right atrium of heart due to

- (1) Pressure difference between the post caval and atrium
- (2) Pushing open of the venous valves
- (3) Suction pull
- (4) Stimulation of the sino auricular node

Sol. Answer (1)

Blood always flows from higher pressure towards the lower pressure.

158. In humans, at the end of the first meiotic division, the male germ cells differentiate into the

- | | |
|-----------------------------|---------------------------|
| (1) Spermatozoia | (2) Primary spermatocytes |
| (3) Secondary spermatocytes | (4) Spermatids |

164. Which extraembryonic membrane in humans prevents desiccation of the embryo inside the uterus?

- (1) Amnion
- (2) Chorion
- (3) Allantois
- (4) Yolk sac

Sol. Answer (1)

Amnion encloses amniotic fluid which prevents desiccation of embryo, that's why present in all true land vertebrates.

165. Which one of the following statements is incorrect about menstruation?

- (1) The beginning of the cycle of menstruation is called menarche
- (2) During normal menstruation about 40 ml blood is lost
- (3) The menstrual fluid can easily clot
- (4) At menopause in the female, there is especially abrupt increase in gonadotropic hormones

Sol. Answer (3)

Menopause is a senile change in ovaries. After menopause the level of pituitary gonadotropins remain same or slightly increase. FSH is more than LH; but the ovaries are not responding to these hormone, because all the ovarian follicles are converted into follicular atresia. There is decline in the level of progesterone and estrogen.

Initially the blood inside the uterus clots, but it is liquefied by the enzyme plasmin released by uterus. Menstrual fluid which is discharged cannot clot again.

166. The haemoglobin of a human foetus

- (1) Has a higher affinity for oxygen than that of an adult
- (2) Has a lower affinity for oxygen than that of the adult
- (3) Its affinity for oxygen is the same as that of an adult
- (4) Has only 2 protein subunits instead of 4

Sol. Answer (1)

The haemoglobin of human foetus (HbF) has 4 Heme group and 1 globin. In HbF the globin protein is made up of 2α and 2β polypeptide chains. Each α has 141 amino acids and each β -has 146 amino acids but 37 amino acids in each β are different from that of HbA. It has higher affinity for O_2 even at low PO_2 and the oxygen-Hb dissociation curve remains towards the left of normal.

167. Consider the statements given below regarding contraception and answer as directed thereafter

- (a) Medical Termination of Pregnancy (MTP) during first trimester is generally safe
- (b) Generally chances of conception are nil until mother breast-feeds the infant upto two years
- (c) Intrauterine devices like copper-T are effective contraceptives
- (d) Contraception pills may be taken upto one week after coitus to prevent conception

Which two of the above statements are correct?

- (1) a, b
- (2) b, c
- (3) c, d
- (4) a, c

Sol. Answer (4)

During intense lactational period the chances of conception are almost nil, maximum upto six months and not two years.

After unwanted sexual intercourse, conception can be avoided by taking contraceptive pills within 72 hrs.

168. In human adult females oxytocin

- (1) Causes strong uterine contractions during parturition
- (2) Is secreted by anterior pituitary
- (3) Stimulates growth of mammary glands
- (4) Stimulates pituitary to secrete vasopressin

Sol. Answer (1)

Oxytocin is called as Birth Hormone as it causes the contraction of smooth muscles of the uterus leading to the birth of the child.

169. Which one of the following is the correct percentage of the two (out of the total of 4) green house gases that contribute to the total global warming?

- (1) Methane 20%, N₂O 18%
- (2) CFCs 14%, Methane 20%
- (3) CO₂ 40%, CFSs 30%
- (4) N₂O 6%, CO₂ 86%

Sol. Answer (2)

CFC 14%, methane 20% : For CO₂ it is 60% and for N₂O it is 6%

170. *Quercus* species are the dominant component in

- (1) Tropical rain forests
- (2) Temperate deciduous forests
- (3) Alpine forests
- (4) Scrub forests

Sol. Answer (2)

Temperate deciduous forest

Tropical rain forest – *Dipterocarpus*, *Hopea*

Scrub forest – Oak, *Eucalyptus*

Alpine forest – *Rhododendron*, *Juniperus*

171. About 70% of total global carbon is found in

- (1) Forests
- (2) Grasslands
- (3) Agroecosystems
- (4) Oceans

Sol. Answer (4)

Oceans : For the C, cycling pool consists of 6×10^{14} kg (29%) of free CO₂ in the atmosphere and 1.45×10^{15} kg (71%) dissolved CO₂ in hydrosphere.

172. Which one of the following is not observed in biodiversity hotspots?

- (1) Species richness
- (2) Endemism
- (3) Accelerated species loss
- (4) Lesser inter-specific competition

Sol. Answer (4)

Lesser inter-specific competition : Due to the presence of high species diversity the inter specific competition will be more enhanced.

173. World summit on Sustainable Development (2002) was held in

- (1) South Africa
- (2) Brazil
- (3) Sweden
- (4) Argentina

Sol. Answer (1)

It was held in South Africa (Johnnesberg)

174. The slow rate of decomposition of fallen logs in nature is due to their

- (1) Low cellulose content
- (2) Low moisture content
- (3) Poor nitrogen content
- (4) Anaerobic environment around them

Sol. Answer (2)

Low moisture content will lead to decrease in number of decomposers, because decomposers require an optimum moisture for their proper growth and functioning.

175. Consider the following statements concerning food chains

- (a) Removal of 80% tigers from an area resulted in greatly increased growth of vegetation
- (b) Removal of most of the carnivores resulted in an increased population of deers
- (c) The length of food chains is generally limited to 3-4 trophic levels due to energy loss
- (d) The length of food chains may vary from 2 to 8 trophic levels.

Which two of the above statements are correct?

- (1) a, b
- (2) b, c
- (3) c, d
- (4) a, d

Sol. Answer (2)

Removal of tigers from an area will lead to an increase in number of herbivores and hence there will be decreased growth of vegetation in that particular area.

The number of trophic levels in a food chain does not reach 8 rather there are 3 or 4 trophic levels.

176. According to Central Pollution Control Board (CPCB), which particulate size in diameter (in micrometers) of the air pollutants is responsible for greatest harm to human health?

- (1) 5.2 - 2.5
- (2) 2.5 or less
- (3) 1.5 or less
- (4) 1.0 or less

Sol. Answer (2)

This is the report of Central Pollution Control Board.

177. The table below gives the populations (in thousands) of ten species (A - J) in four areas (a - d) consisting of the number of habitats given within brackets against each. Study the table and answer the question which follows

Area and Number of habitats	Species, and their populations (in thousands) in the areas									
	A	B	C	D	E	F	G	H	I	J
a (11)	2.3	1.2	0.52	6.0	-	3.1	1.1	9.0	-	10.3
b (11)	10.2	-	0.62	-	1.5	3.0	-	8.2	1.1	11.2
c (13)	11.3	0.9	0.48	2.4	1.4	4.2	0.8	8.4	2.2	4.1
d (12)	3.2	10.2	11.1	4.8	0.4	3.3	0.8	7.3	11.3	2.1

Which area out of a to d shows maximum species diversity?

- (1) a
- (2) b
- (3) c
- (4) d

Sol. Answer (4)

In areas 'c' and 'd' all the 10 species are present but number of habitats is lesser in area d.

178. A lake near a village suffered heavy mortality of fishes within a few days. Consider the following reasons for this

- (a) Lots of urea and phosphate fertilizer were used in the crops in the vicinity
- (b) The area was sprayed with DDT by an aircraft
- (c) The lake water turned green and stinky
- (d) Phytoplankton populations in the lake declined initially thereby greatly reducing photosynthesis

Which two of the above were the main causes of fish mortality in the lake?

- (1) a, b
- (2) b, c
- (3) c, d
- (4) a, c

Sol. Answer (4)

Lots of urea and phosphate fertilizers used in crops in the vicinity of lake will lead to eutrophication that means the lake will turn green and stinky.

179. Consider the following four statements (a - d) about certain desert animals such as kangaroo rat.

- (a) They have dark colour and high rate of reproduction and excrete solid urine
- (b) They do not drink water, breathe at a slow rate to conserve water and have their body covered with thick hairs
- (c) They feed on dry seeds and do not require drinking water
- (d) They excrete very concentrated urine and do not use water to regulate body temperature

Which two of the above statements for such animals are true?

- (1) a and b
- (2) c and d
- (3) b and c
- (4) c and a

Sol. Answer (2)

Kangaroo rat is the only mammal which does not ingest any water and remains only on metabolic water which it can utilize due to nasal counter current mechanism. It feeds on dry castor seeds. Sweat glands are absent and secrete concentrated urine with nitrogenous waste as urea.

180. A transgenic food crop which may help in solving the problem of night blindness in developing countries is

- (1) Golden rice
- (2) Flavr Savr tomatoes
- (3) Starlink maize
- (4) Bt Soybean

Sol. Answer (1)

Golden rice is transgenic rice in which the genes for synthesis of enzymes involved in β -carotene formation are transferred. So golden rice is rich in vitamin A, preventing night blindness.

181. Bacterial leaf blight of rice is caused by a species of

- (1) *Erwinia*
- (2) *Xanthomonas*
- (3) *Pseudomonas*
- (4) *Alternaria*

Sol. Answer (2)

Xanthomonas oryzae.

182. Which one of the following is linked to the discovery of Bordeaux mixture as a popular fungicide?

- (1) Black rust of wheat
- (2) Bacterial leaf blight of rice
- (3) Downy mildew of grapes
- (4) Loose smut of wheat

Sol. Answer (3)

It was discovered by Professor Millardet of Bordeaux University of France.

183. Which one of the following is being tried in India as a biofuel substitute for fossil fuels?

- (1) *Aegilops*
- (2) *Jatropha*
- (3) *Azadirachta*
- (4) *Musa*

Sol. Answer (2)

It is a petroplant and the source of fuel is latex.

184. *Trichoderma harzianum* has proved a useful microorganism for

- (1) Biological control of soil-borne plant pathogens
- (2) Bioremediation of contaminated soils
- (3) Reclamation of wastelands
- (4) Gene transfer in higher plants

Sol. Answer (1)

It secretes chitinase enzyme which is responsible for antifungal activities.

185. Gel electrophoresis is used for

- (1) Isolation of DNA molecule
- (2) Cutting of DNA into fragments
- (3) Separation of DNA fragments according to their size
- (4) Construction of recombinant DNA by joining with cloning vectors

Sol. Answer (3)

After the action of restriction endonuclease the fragments of DNA so formed are separated by gel electrophoresis. This technique is based upon the principle of separation of molecules on the basis of charge and mass.

186. To which type of barriers under innate immunity, do the saliva in the mouth and the tears from the eyes, belong?

- (1) Physical barriers
- (2) Cytokine barriers
- (3) Cellular barriers
- (4) Physiological barriers

Sol. Answer (4)

Acid in stomach, saliva in mouth, tears from eyes all prevent microbial growth. They are part of innate immunity and grouped under physiological barriers.

187. Match the disease in Column I with the appropriate items (pathogen/prevention/treatment) in Column II

Column I	Column II
(a) Amoebiasis	(i) <i>Treponema palladium</i>
(b) Diphtheria	(ii) Use only sterilized food and water
(c) Cholera	(iii) DPT Vaccine
(d) Syphilis	(iv) Use oral rehydration therapy
(1) a-(ii), b-(iii), c-(iv), d-(i)	(2) a-(i), b-(ii), c-(iii), d-(iv)
(3) a-(ii), b-(iv), c-(i), d-(iii)	(4) a-(ii), b-(i), c-(iii), d-(iv)

Sol. Answer (1)

188. Consider the following statements about biomedical technologies

- (a) During open heart surgery blood is circulated in the heart-lung machine
- (b) Blockage in coronary arteries is removed by angiography
- (c) Computerised Axial Tomography (CAT) shows detailed internal structure as seen in a section of body
- (d) X-ray provides clear and detailed images of organs like prostate glands and lungs

Which two of the above statements are correct?

- (1) a and b
- (2) b and d
- (3) c and d
- (4) a and c

Sol. Answer (4)

Angioplasty not **angiography** is unblocking of blocked arteries. Radiograph produced by x-rays is just a shadow of the dense body parts.

189. Which one of the following pairs of codons is correctly matched with their function or the signal for the particular amino acid?

- (1) UUA, UCA - Leucine
- (2) GUU, GCU - Alanine
- (3) UAG, UGA - Stop
- (4) AUG, ACG - Start / Methionine

Sol. Answer (3)

UAA, UAG and UGA are nonsense or terminating or stop codons as these are responsible for the termination of translation.

190. Which one of the following is the correct statement regarding the particular psychotropic drug specified?

- (1) *Barbiturates* cause relaxation and temporary euphoria
- (2) *Hashish* causes altered thought perceptions and hallucinations
- (3) *Opium* stimulates nervous system and causes hallucinations
- (4) *Morphine* leads to delusions and disturbed emotions

Sol. Answer (2)

Morphine is both a sedative as well as analgesic drug. Barbiturates are sedatives and have hypnotic effect. Opium is also a narcotic drug which has a depressing effect on CNS.

191. Cry 1 endotoxins obtained from *Bacillus Thuringiensis* are effective against

- (1) Boll worms
- (2) Mosquitoes
- (3) Flies
- (4) Nematodes

Sol. Answer (1)

Proteins encoded by the genes cry I Ac and cry II Ab control cotton bollworm.

192. Modern detergents contain enzyme preparations of

- (1) Thermophiles
- (2) Acidophiles
- (3) Alkaliphiles
- (4) Thermoacidophiles

Sol. Answer (2)

Enzymes used in detergents are proteases and lipases, which are obtained from fungi. Fungi grows properly in acidic medium.

193. The linking of antibiotic resistance gene with the plasmid vector became possible with

- (1) Exonucleases
- (2) DNA ligase
- (3) Endonucleases
- (4) DNA polymerase

Sol. Answer (2)

Restriction endonucleases act as molecular scissors; but DNA ligases help in linking foreign DNA to plasmid.

194. Which one of the following proved effective for biological control of nematodal disease in plants?

- (1) *Paecilomyces lilacinus*
- (2) *Pisolithus tinctorius*
- (3) *Pseudomonas cepacia*
- (4) *Gliocladium virens*

Sol. Answer (3)

195. Main objective of production/use of herbicide resistant GM crops is to

- (1) Reduce herbicide accumulation in food articles for health safety
- (2) Eliminate weeds from the field without the use of manual labour
- (3) eliminate weeds from the field without the use of herbicides
- (4) Encourage eco-friendly herbicides

Sol. Answer (2)

As herbicide resistant GM crops will remain unaffected to the herbicide used, while the weeds will get killed.

196. Consider the following four measures (a - d) that could be taken to successfully grow chick-pea in an area where bacterial blight disease is common

- (a) Spray with Bordeaux mixture
- (b) Control of the insect vector of the disease pathogen
- (c) Use of only disease-free seeds
- (d) Use of varieties resistant to the disease

Which two of the above measures can control the disease?

- (1) (a) and (d)
- (2) (b) and (c)
- (3) (a) and (b)
- (4) (c) and (d)

Sol. Answer (4)

Bordeaux is used to control fungal diseases and no insect vector is reported for bacterial blight disease. Thus use of disease free seeds and disease resistant varieties can control disease.

197. Human insulin is being commercially produced from a transgenic species of

- (1) *Saccharomyces*
- (2) *Escherichia*
- (3) *Mycobacterium*
- (4) *Rhizobium*

Sol. Answer (2)

Eli Lilly was the first American Company to launch genetically engineered insulin called as **humulin**. They prepared two DNA sequences by reverse transcription of their m-RNA and linked them separately with the modified plasmid of *Escherichia coli*.

198. Cornea transplant in humans is almost never rejected. This is because

- (1) It is a non-living layer
- (2) Its cells are least penetrable by bacteria
- (3) It has no blood supply
- (4) It is composed of enucleated cells

Sol. Answer (3)

Cornea can be easily transplanted because it has no blood supply & therefore, does not involve immune response.

199. Which of the following pairs of organs includes only the endocrine glands?

- (1) Adrenal and Ovary
- (2) Parathyroid and Adrenal
- (3) Pancreas and Parathyroid
- (4) Thymus and Testes

Sol. Answer (2)

Testes, Ovaries and Pancreas have both exocrine and endocrine functions; but Parathyroid and Adrenals have only endocrine function.

200. What is antisense technology?

- (1) RNA polymerase producing DNA
- (2) A cell displaying a foreign antigen used for synthesis of antigens
- (3) Production of somaclonal variants in tissue cultures
- (4) When a piece of RNA that is complementary in sequence is used to stop expression of a specific gene

Sol. Answer (4)

Antisense technology is the translational control of protein synthesis which involves use of RNA which is complementary to m-RNA, inhibiting the expression of genes.