

# Bihar Board Class 8 Maths Solutions Chapter 7 ज्यामितीय आकृतियों की रचना

---

## Bihar Board Class 8 Maths ज्यामितीय आकृतियों की रचना Ex 7.1

---

प्रश्न 1.

प्रश्न 2.

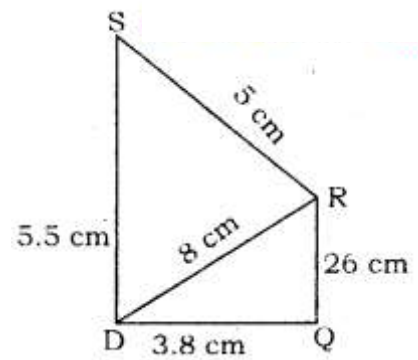
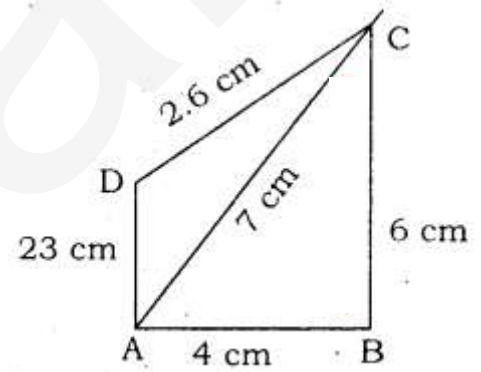

## Bihar Board Class 8 Maths ज्यामितीय आकृतियों की रचना Ex 7.2

---

प्रश्न 1.

प्रश्न 2.

प्रश्न 3.

प्रश्न 4.

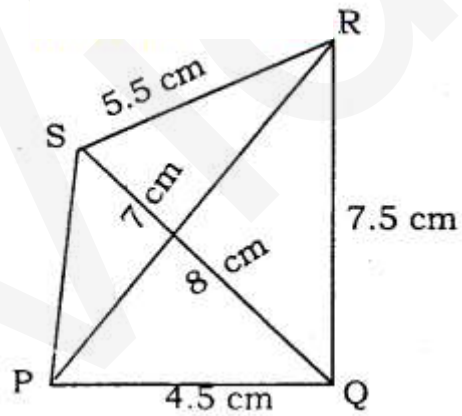
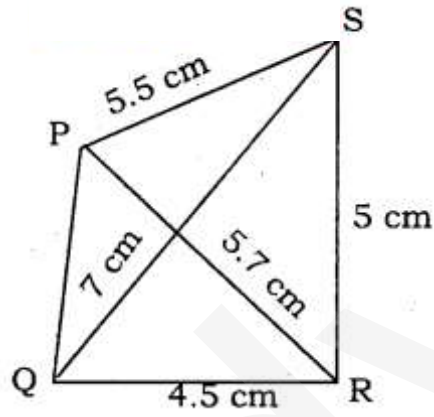
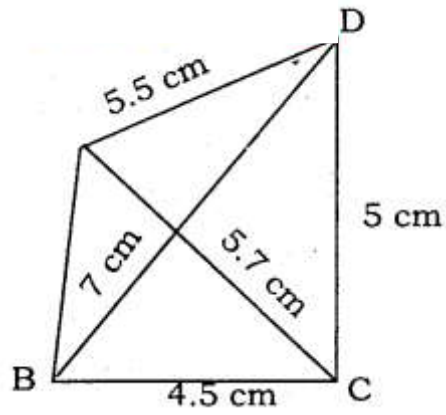

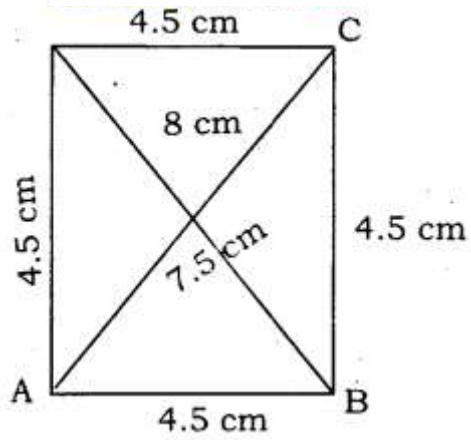

**Bihar Board Class 8 Maths ज्यामितीय आकृतियों की रचना Ex 7.3**

प्रश्न 1.

प्रश्न 2.

प्रश्न 3.

प्रश्न 4.

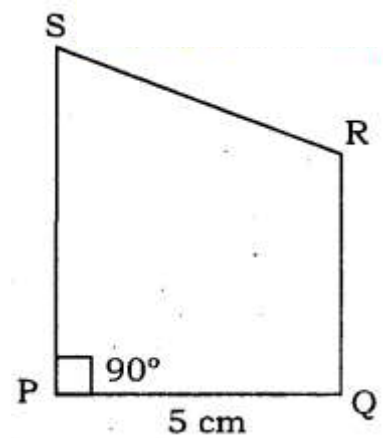
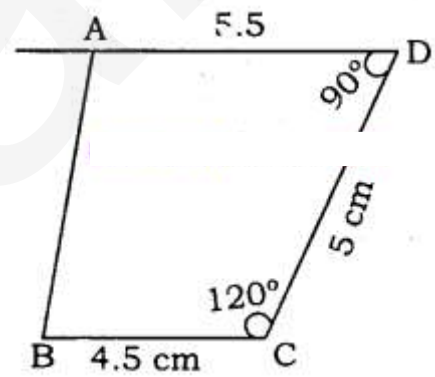

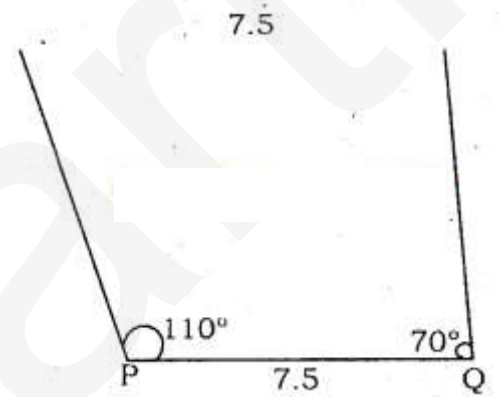
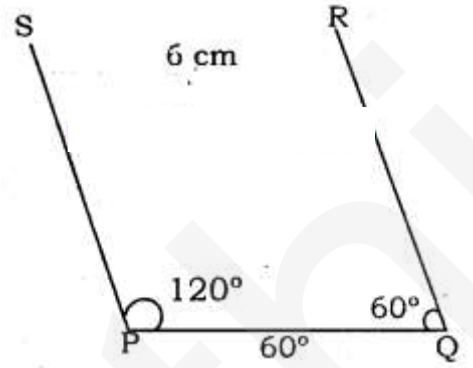

**Bihar Board Class 8 Maths ज्यामितीय आकृतियों की रचना Ex 7.4**

प्रश्न 1.

प्रश्न 2.

प्रश्न 3.

प्रश्न 4.

